



Connecting globally

A photograph of an industrial facility at night, with various structures and towers illuminated against a dark sky. The image is overlaid with a green grid pattern.

High and extra high  
voltage cables \_\_\_\_\_

## Bydgoszcz plant

The largest production center for medium, high and extra high voltage cables in Europe.

Starting from the first installation in 1992 of 110kV XLPE cable system in Poland, TELE-FONIKA Kable has extensive experience in offering high voltage cable systems in the international market. Over the past 25 years TELE-FONIKA Kable has completed over 200 HV cable systems projects. Using this experience we are able to offer advice and support for turnkey projects such as cable system selection, the routing of the cable circuit, installation of equipment as well as post installation testing.

# Leading producer of cables and cable systems

The TELE-FONIKA Kable Group has been present on the domestic and international cable industry market for more than 25 years. A stable development strategy based on full diversification of outlets enabled the strengthening of the position of our company among world's leading cable companies with significant development potential.

Services and products provided by TF Kable have numerous applications in the most important industry sectors – they include more than 25,000 proven standard constructions. Furthermore, they include specialist assortment tailored to the individual needs of business partners.

Additionally, our production facilities (in Poland and Serbia), the Bukowno-Poland recycling plant and commercial companies (responsible for the geo-regional distribution of products) demonstrate a significant development potential. This is also true in the case of our modern fire test laboratory in Krakow-Wielicka plant, which performs several hundred flammability pre-tests annually, and a laboratory of high and extra high voltages in Bydgoszcz.

As a result of implementation of our growth strategy, in August 2017 TFKable Group acquired JDR Cable Systems Ltd, the leading manufacturer of submarine umbilicals and power cables to the global offshore energy industry.

In the world's harshest environments and ever-increasing water depths, JDR's world-leading products and services bring power and control to offshore oil, gas and renewable energy systems.



# TFK.GROUP Production and distribution – locations

## Manufacturing plants

## Service units and subsidiaries

### UK

**JDR Littleport Plant, UK**  
Production of cables and wires

**JDR Hartlepool Plant, UK**  
Production of cables and wires

**Copper Cable Company Ltd  
Leicestershire, UK**  
Distribution of cables and wires

**JDR Newcastle, UK**  
Trade and service unit

**JDR Blyth Plant, UK – under construction**  
Production of cables and wires

### Poland

**TELE-FONIKA Kable S.A.  
Bydgoszcz Plant, PL**  
Production of cables and wires

**TELE-FONIKA Kable S.A.  
Bukowno Plant, PL**  
Post-production waste recycling plant

**TELE-FONIKA Kable S.A.  
Myślenice Plant, PL**  
Production of cables and wires

**TELE-FONIKA Kable S.A.  
Kraków-Wielicka Plant, PL**  
Production of cables and wires

**TELE-FONIKA Kable S.A.  
Kraków-Bieżanów Plant, PL**  
Energy Storage Units production

### Germany

**TELE-FONIKA Kable Central  
Europe GmbH Hilden, DE**  
Distribution of cables and wires

### Lithuania

**UAB TELE-FONIKA Baltic  
Kowno, LT**  
Distribution of cables and wires

### US

**TF Cable Americas  
Bolingbrook, IL, US**  
Distribution of cables and wires

**JDR Tomball, TX, US**  
Trade and service unit

### Serbia

**TF Kable FKZ Zajecar, SRB**  
Production of cables and wires,  
trade unit

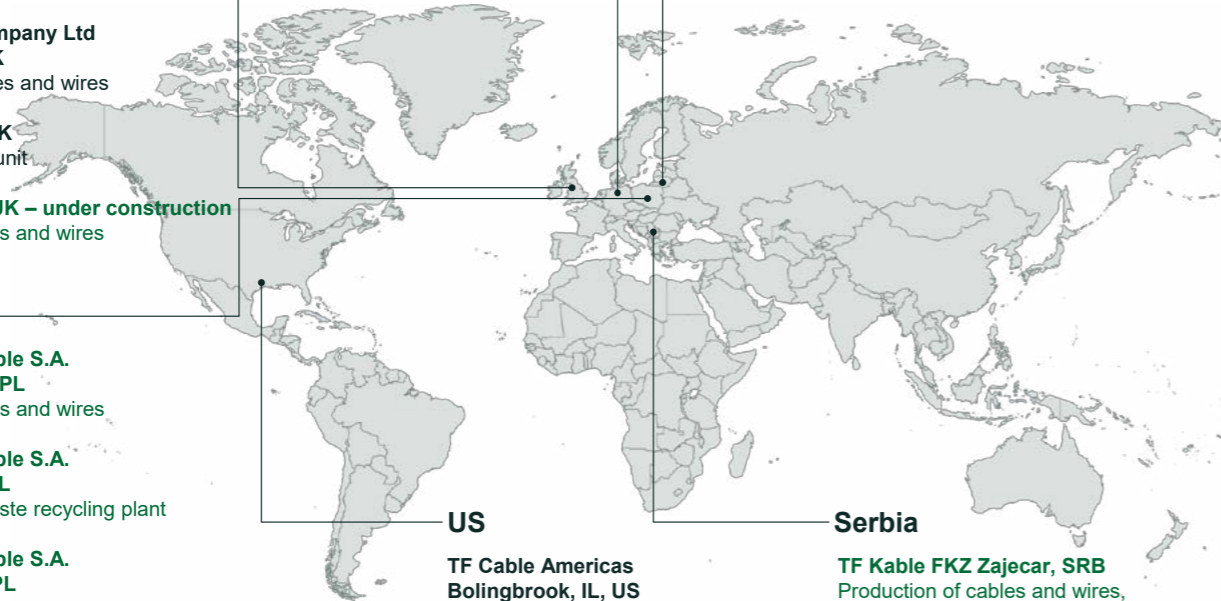

## Experience and competence of the TELE-FONIKA Kable Group global relations

**Kraków-Wielicka plant** – it produces cables and wires with voltage ranging from 1kV to 30kV, including rubber insulation, used in the extractive industry and wind farms; halogen-free cables and conductors (installed inside buildings); and signaling and control cables for special applications

**Kraków-Bieżanów plant** – production of overhead lines from alloyed aluminum, silver plated copper conductors for railway traction networks, made on robotic technology lines

**Bydgoszcz plant** – the largest production center for medium, high and extra high voltage cables in Europe

**Myślenice plant** – production of copper and fiber optic telecommunication cables, computer cables and car cables

**Zajecar plant (Serbia)** – production of low and medium voltage cables, signaling and control cables, telecommunication cables, as well as halogen-free cables and wires

**Bukowno-Poland plant (recycling of cable waste)** – it has the recycling capacity of approx. 10 thousand tons of cable waste per year. This allows for the recovery of fractions from individual materials with purity of over 99.5%

**Fire Test Laboratory in the Krakow-Wielicka production plant** – it is equipped with apparatus that enables to conduct research ranging from basic tests of flame spreading on individual samples to flame spreading tests on bundles. Furthermore, it is equipped for testing density of emitted fumes and emission of corrosive gases

**Laboratory of High and Extreme Voltages in the production plant in Bydgoszcz** – equipped with 4 Faraday cages (three for routine testing and one for cables and cable systems testing) along with a stroke generator and its own research field for qualification tests with 500kV testing systems and 5000A heating transformer sets

**JDR Cable Systems** – As a result of acquiring JDR Cable Systems Limited, TFKable has expanded its assets with two UK production Facilities. JDR manufactures submarine power cables as well as subsea umbilical cables consisting of components for power distribution, data transfer, monitoring and remote control, of offshore facilities. Additionally, our sales portfolio has been extended by offshore installation and maintenance services, located in JDR's service centres in the United States and UK, ensuring constant support for our business partners.

## Table of contents

3 Leading producer of cables and cable systems

11 High-voltage cables

12 Proposal

14 The Quality Management System

15 Manufacturing processes

20 Types of cable

HV XLPE cable with copper wires screen and aluminium laminated foil

24 26/45 ÷ 47 (52) kV COPPER CONDUCTOR

26 26/45 ÷ 47 (52) kV ALUMINIUM CONDUCTOR

28 36/60 ÷ 69 (72.5) kV COPPER CONDUCTOR

30 36/60 ÷ 69 (72.5) kV ALUMINIUM CONDUCTOR

32 64/110 ÷ 15 (123) kV COPPER CONDUCTOR

34 64/110 ÷ 115 (123) kV ALUMINIUM CONDUCTOR

## Table of contents

---

36	76/132 ÷ 138 (145) kV COPPER CONDUCTOR
38	76/132 ÷ 138 (145) kV ALUMINIUM CONDUCTOR
40	87/150 ÷ 161 (170) kV COPPER CONDUCTOR
42	87/150 ÷ 161 (170) kV ALUMINIUM CONDUCTOR
44	127/220 ÷ 230 (245) kV COPPER CONDUCTOR
46	127/220 ÷ 230 (245) kV ALUMINIUM CONDUCTOR
48	220/380 ÷ 400 (420) kV COPPER CONDUCTOR
50	220/380 ÷ 400 (420) kV ALUMINIUM CONDUCTOR
52	290/500 (550) kV COPPER CONDUCTOR
54	290/500 (550) kV ALUMINIUM CONDUCTOR
<hr/> <b>HV XLPE cable with corrugated aluminium sheath</b> <hr/>	
58	26/45 ÷ 47 (52) kV COPPER CONDUCTOR
60	26/45 ÷ 47 (52) kV ALUMINIUM CONDUCTOR

## Table of contents

---

62	36/60 ÷ 69 (72.5) kV COPPER CONDUCTOR
64	36/60 ÷ 69 (72.5) kV ALUMINIUM CONDUCTOR
66	64/110 ÷ 115 (123) kV COPPER CONDUCTOR
68	64/110 ÷ 115 (123) kV ALUMINIUM CONDUCTOR
70	76/132 ÷ 138 (145) kV COPPER CONDUCTOR
72	76/132 ÷ 138 (145) kV ALUMINIUM CONDUCTOR
74	87/150 ÷ 161 (170) kV COPPER CONDUCTOR
76	87/150 ÷ 161 (170) kV ALUMINIUM CONDUCTOR
78	127/220 ÷ 230 (245) kV COPPER CONDUCTOR
80	127/220 ÷ 230 (245) kV ALUMINIUM CONDUCTOR
82	220/380 ÷ 400 (420) kV COPPER CONDUCTOR
84	220/380 ÷ 400 (420) kV ALUMINIUM CONDUCTOR
86	290/500 (550) kV COPPER CONDUCTOR

## Table of contents

---

88 290/500 (550) kV ALUMINIUM CONDUCTOR

---

HV XLPE cable with lead alloy sheath

---

92 26/45 ÷ 47 (52) kV COPPER CONDUCTOR

---

94 26/45 ÷ 47 (52) kV ALUMINIUM CONDUCTOR

---

96 36/60 ÷ 69 (72.5) kV COPPER CONDUCTOR

---

98 36/60 ÷ 69 (72.5) kV ALUMINIUM CONDUCTOR

---

100 64/110 ÷ 115 (123) kV COPPER CONDUCTOR

---

102 64/110 ÷ 115 (123) kV ALUMINIUM CONDUCTOR

---

104 76/132 ÷ 138 (145) kV COPPER CONDUCTOR

---

106 76/132 ÷ 138 (145) kV ALUMINIUM CONDUCTOR

---

108 87/150 ÷ 161 (170) kV COPPER CONDUCTOR

---

110 87/150 ÷ 161 (170) kV ALUMINIUM CONDUCTOR

---

112 127/220 ÷ 230 (245) kV COPPER CONDUCTOR

---

## Table of contents

---

114 127/220 ÷ 230 (245) kV ALUMINIUM CONDUCTOR

---

116 220/380 ÷ 400 (420) kV COPPER CONDUCTOR

---

118 220/380 ÷ 400 (420) kV ALUMINIUM CONDUCTOR

---

120 Ampacity

---

130 Installation correction factors

---

135 Worked example

---

136 Equations

---

141 Types of cable system bondings

---

142 Cable drums

---

Notes

---

147 N2XS(FL)2Y1 × 2500 400kV

---

The information contained in this document, including the tables and drawings, are provided for illustrative purposes only and not a commercial offer; nor may it constitute the basis for pursuing any claim against TELE-FONIKA KABLE SA. The suitability of any product including properties, should be made by a qualified person; having already gained the appropriate permissions and documentation, to ensure compliance with any applicable law or regulation.



## Experience and Innovation

## High-voltage cables

Today we are all part of a highly mechanised society, we habitually utilise technologies for business and daily life that would have been thought impossible only 10 years ago. Living in such an industrial world it is easy to forget that the most essential element, that allows all of these technologies to function, is a reliable supply of energy. We take it for granted, but without a safe and efficient energy infrastructure, the industrialised world would cease to function. The efficient and reliable transmission of electricity is crucial. The higher the voltage, the greater the need for efficiency and safety. If a high voltage cable fails it can be disastrous. Therefore, choosing a cable brand with a proven track record of manufacturing excellence and reliability is of the utmost importance.

The transmission of high voltage electricity through a network of cable systems has always been a technological challenge. However that challenge becomes even greater when transmission through overhead lines is unacceptable and an underground system must be adopted.

When a cable is laid in the ground, the insulation becomes of paramount importance. The current's natural inclination is to return to earth and so the conductor must be well insulated to prevent losses.

Historically, HV fluid impregnated multi-layered paper dielectric cables were installed, and whilst having a proven history of reliable use, they required a much greater degree of system design complexity. Provisions had to be made for oil tanks and calculations of the hydraulic oil flow had to be taken into consideration. Additionally, the systems need a continual maintenance regime as any oil leaks from these cables raised serious environmental concerns and possible cable failure.

The development of a reliable method of crosslinking polyethylene has meant that the use of a paper taped dielectric has become all but obsolete.

The use of cross-linked polyethylene proved to be a breakthrough. Not only is it a more cost effective solution, these cable systems require little, if any, regular maintenance.

XLPE cable systems allow for efficient transmission of energy, whilst having a comparatively low degree of design and installation complexity. This technology has gradually been developed to enable the creation of cable systems working with a voltage up to 500 kV.

### The main advantages of underground XLPE insulated cable circuits include:

- Low electrical losses,
- Easier installation,
- High degree of reliability and safety,
- Minimal impact on the environment,
- No unsightly cable towers in populated centres or areas of natural beauty,
- Lower magnetic field than overhead lines,
- Elimination of cable oil leaks into the environment,
- Modern manufacturing methods mean each stage, of insulating process is reported and fully traceable.

For over 20 years TELE-FONIKA Kable have been manufacturing high and extra high voltage cables at its factory in Bydgoszcz. Since the first Nokia Maillfer CCV line was installed in 1998, this plant has seen extensive investment in new plant and testing facilities. Currently, it has 7 operational Nokia Maillfer CCV lines, with plans to increase this to 8 over the next year. This will mean that the Bydgoszcz factory has the largest high voltage production capacity in Europe.

The current position of the company TELE-FONIKA Kable is the result of continuous research, development and innovation of machinery, combined with the use of high-quality materials. We work with the best cable accessory manufacturers, which ensures that the cable systems we provide are reliable and of the highest quality.

The experiences gained from the manufacture, supply and installation of over 5.000 km of high voltage cables, and their continued operation in over 40 countries around the world, allow us to create a comprehensive offer corresponding to the most demanding users.

# Proposal

---

## Cable systems

Starting from the first installation in 1992 of 110kV XLPE cable system in Poland, TELE-FONIKA Kable has extensive experience in offering high voltage cable systems in the international market.

Over the past 20 years TELE-FONIKA Kable has completed over 200 HV cable systems projects. Using this experience we are able to offer advice and support for turnkey projects such as cable system selection, the routing of the cable circuit, installation of equipment as well as post installation testing.

## Providing System Solutions

Our experienced and highly qualified engineers are able to offer advice and consultancy services to meet with customer requirements:

- Design and optimisation of cable structures, including the calculation of current-carrying capacity and other important electrical parameters,
- Preparation of complex proposals of high voltage systems, covering; the supply of cable and accessories, installation and post-installation testing,
- Consultancy on the design of cable systems: selection of accessories, optimization of working conditions of the cable, etc.

## Continuous temperature measurement system (DTS)

TELE-FONIKA Kable can offer high voltage cable systems with an inbuilt facility to enable the continuous measurement of cable temperature based on DTS technique (Distributed Temperature Sensing). In this technique the temperature sensing function is performed by a fibre placed in a protective tube which is laid within the copper wire screen during cable manufacture.

This solution negates the need to lay an additional DTS cable at the installation stage, and with the correct selection of accessories, can connect the monitoring apparatus directly to the cable.

## Selection of cable and accessories

TELE-FONIKA Kable can offer many different variations of cable designs to meet your requirements. We have the design resource to enable you to select the cable and equipment necessary to meet the specific technical and operational parameters that your cable systems require, including:

Selection of conductor cross sections, based on the required current carrying capacity of the cable circuit,

Selection of the metallic sheath's nominal cross section, based on the required short-circuit current capacity duration,

- Advice on laying the cable circuit:
  - The distance between parallel circuits
  - Cable alignment (flat/trefoil arrangements)
  - Depth of cable laying, taking into account the soil thermal resistivity,
  - Ducts and their length
- Selection of variants and quantities of cable equipment/ accessories is based on the given data:
  - Foundation/placement of accessories,
  - Operating conditions of cable accessories.

We work closely with our customers in providing practical efficient solutions.



**More than  
just a cable  
supplier**

## The Quality Management System

TELE-FONIKA Kable has implemented a Quality Management System compliant with ISO 9001:2008 and Environmental Protection System compliant with ISO 14001:2004.

The all-inclusive management system covers the entire organisational structure of TELE-FONIKA Kable, supporting every department involved in our cable business, from planning, billing, raw materials ordering and processing.

By providing a product that is consistent with previously agreed specifications, and to the highest quality we demonstrate that we care about our the performance of our customer's end product. They in turn can be safe in the knowledge that they have invested in a product that is reliable, safe to use and will be delivered on time.

This control of operating functions in an integrated management system allows us to proceed in an environmentally sound manner, whilst carrying out our agreed objectives and tasks.

We strive to continually improve our operations and processes, never compromising on the quality of our products, customer satisfaction, professionalism or our environmentally sound operations.

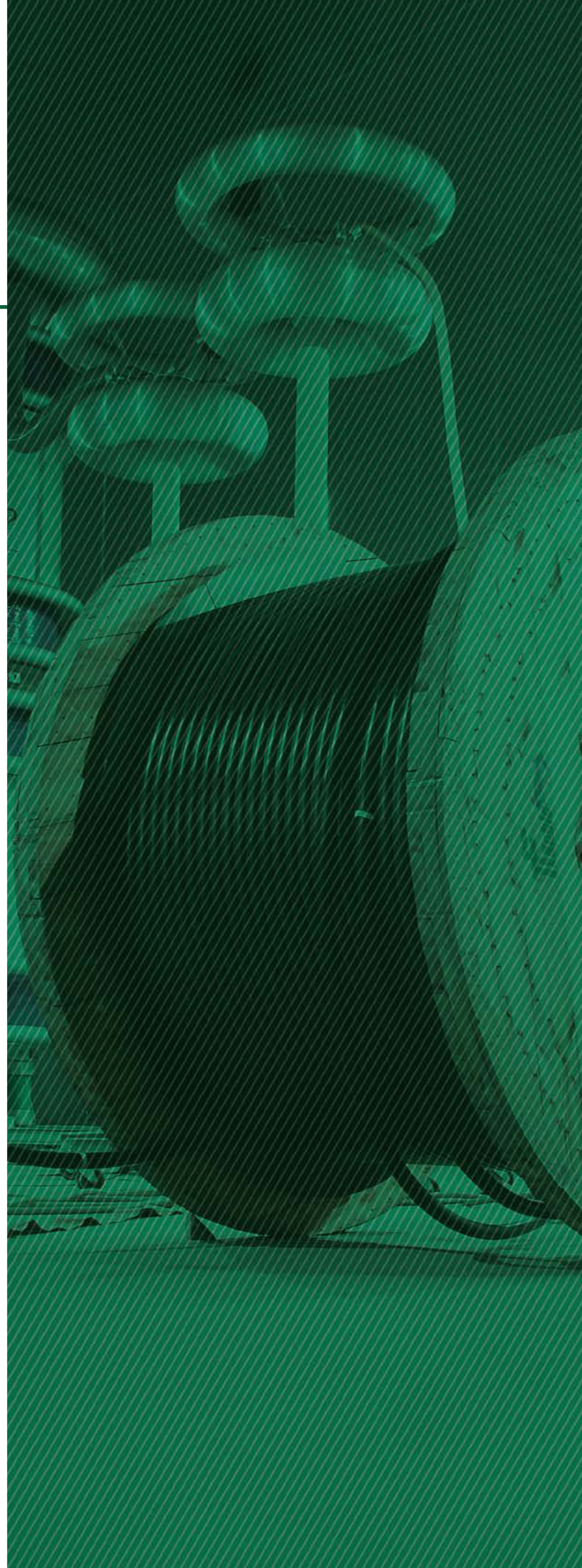

## Manufacturing processes

The manufacture of high voltage cables with extruded XLPE insulation is a series of processes which require highly specialised plant and extreme precision in operation in order to achieve the rigorous demands of the many and varied specifications. TELE-FONIKA Kable has made huge investment in the highest technology plant available.

### Conductors

TELE-FONIKA Kable can manufacture a range of different conductor designs, depending on specified requirements. For current capacity requirements that are satisfied with conductor cross section below 1000 mm<sup>2</sup>; stranded, circular, copper or aluminium conductors are available, with the optional addition of a water blocking sealant. Conductors with a cross section above 1000 mm<sup>2</sup> are manufactured as segmented Milliken conductors (RMS).

### Insulation of conductors

The basic process of manufacture of extruded insulated cable consists of 'triple extruding' the insulating and screening layers onto the conductor which then passes into a curing tube where the temperature of the extrudate is raised to initiate the chemical crosslinking. When the crosslinking is complete the cable passes into a controlled cooling zone.

The triple extrusion process, applies the conductor screen, insulation and core screen in one operation on to the conductor. The state of the art technology employed by TELE-FONIKA Kable allows the continuous on-line control of the most important geometrical parameters of each layer, such as thickness, centricity and ovality. This not only means that any deviation is immediately corrected but also guarantees complete traceability at all stages of the extrusion process.

To ensure the highest quality of the finished cable it is essential to ensure the highest possible cleanliness of the raw materials. The tiniest of foreign particles could result in treeing and in the in the most extreme cases contribute to failure of the finished cable. The Bydgoszcz plant operates 'R3 technology'; a 'superclean' materials handling system which ensures a completely enclosed dust free environment to handle the granular compounds that feed the three extruders.

In the extrusion process, the polyethylene insulation granules are fed into the extruders from chambers which ensure the highest purity of materials. Transportation of semi-conductive and insulating materials are executed through separate supply systems.

The purification of insulating polyethylene granules is performed by the air separator, comprising of magnetic separator, ionizer and cascade air sorter. The magnetic separator produces a strong field, separating any metallic impurities from the polythene granules.

The high quality materials that we use for extrusion are sourced from carefully chosen suppliers with a long and proven track record in this industry. In addition to our strict supplier auditing procedure, a control of each incoming batch of material is performed in our Plant Laboratory.

### The pre-cooling system

To prevent the effect of "leakage of insulation", which may appear in the process of its extrusion, a material with low deformation ratio (low sag type) an 'EHT system' is used. EHT Systems provide an introduction of nitrogen for pre-cooling the extruded insulation to the pipe, in which the cross-linking occurs. This process ensures that the resulting tightly controlled concentricity parameters of the manufactured cores are archived.



### **ROL – a system for relaxation of insulation during the production**

The online relaxation unit consists of an additional heated area located in production line cooling zone. The insulation surface is effectively heated up and then cooled down again. This has three main benefits:

- Increases impulse voltage withstand,
- Reduces internal mechanical stresses,
- Minimises shrink-back behaviour.

### **Degassing of the insulation after the cross-linking process**

During the cross-linking process, the decomposition of cross-linking agent (dicumyl peroxide) to the gaseous residual products (by-products) occurs. The insulated core is subjected to a slow degassing process. This process is carried out in specially heating chambers that ensure controlled degassing conditions. The degassing time is a result of the temperature and insulation thickness and is controlled by our plant laboratory Technicians.

### **Application of the metallic screen**

Application of the metallic screen consists of the following stages:

- Applying the semi-conductive tapes with longitudinal moisture blocking under the metallic screen,
- Applying the copper wires screens and separate copper tape,
- Applying the semi-conductive tapes with longitudinal moisture blocking under the metallic screen,
- Aluminium or Copper foil laminate application as a moisture barrier.

### **Extrusion of the outer sheath**

Extrusion of the outer sheath is the last step in the production of high voltage cables. In the case of cables sealed radially, the Al or Cu tape is longitudinally laid under the outer sheath. The laminate foils are covered with a copolymer of ethylene. In the process of extrusion of coating a durable bonding of the metal tape with outer sheath is made.

### **High Voltage Laboratory**

High Voltage Laboratory is equipped with world class measuring equipment that meet the highest standards of quality. Features of our High Voltage Lab allows us to carry out routine testing of cables and cable systems type tests up to 400 kV, in accordance with current international and national standards or according to customer specifications.

### **Approvals and certificates**

Each complete cable system is tested under the supervision of representatives of an independent laboratory, and when positive results are obtained, it receives a confirmation of the technical characteristics and can be used in high voltage networks.

Tests and research carried out in accordance with applicable standards assure full compatibility of cables with the used cable accessories and guarantee their high quality and reliability.

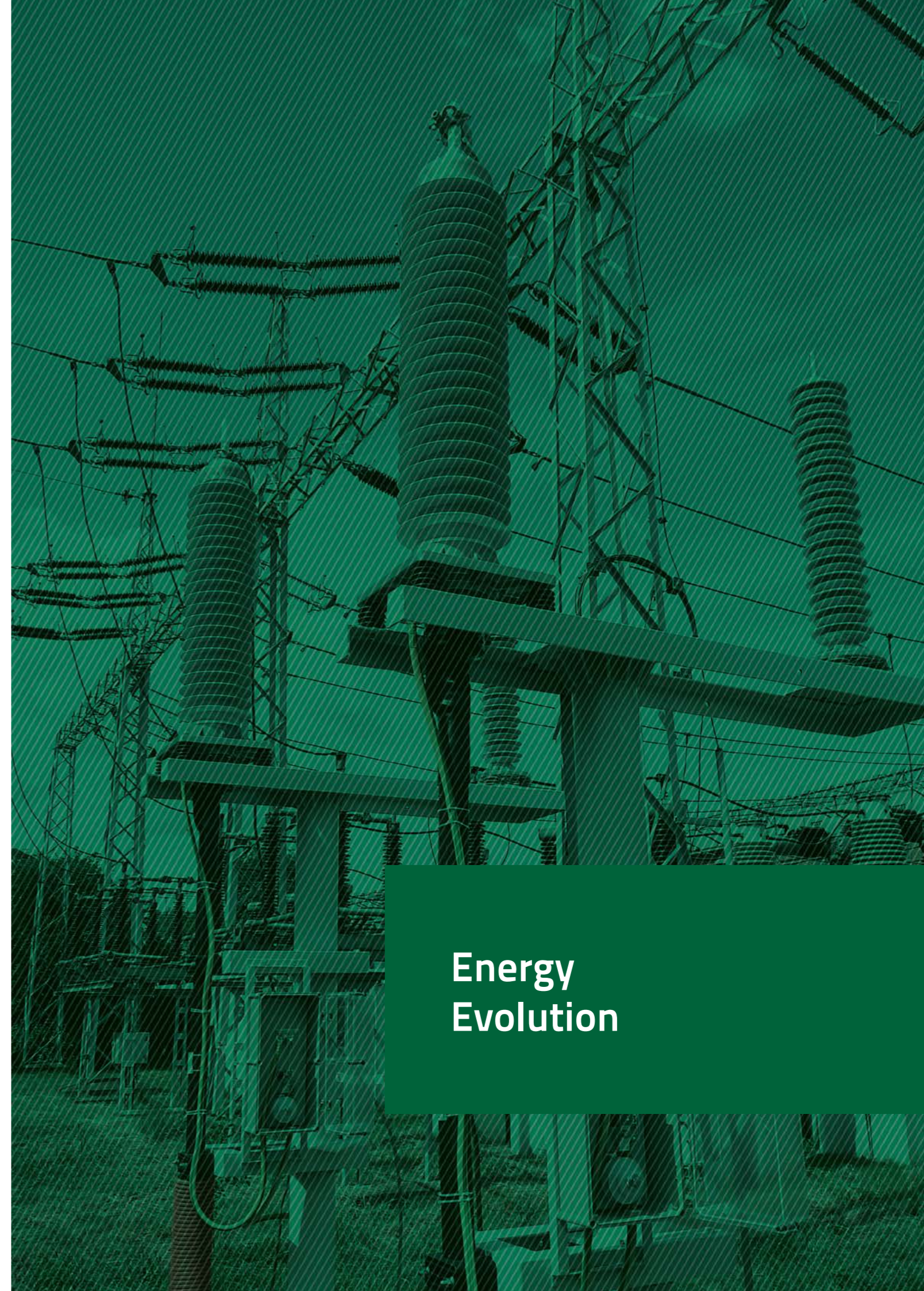

**Energy  
Evolution**



**Energy  
friendly  
environment**

- pollution reduction
- recycling
- social responsibility

# Types of cable

## Cable constructions are shown in the following figures:

Figure 1: HV XLPE cable with copper wires screen and aluminium laminated foil

### Description of Figure 1

1. Aluminium (A) or copper conductor (optional watertightness – WTC)
2. Semi-conductive screen extruded on the phase conductor
3. XLPE insulation
4. Semi-conductive screen extruded on insulation
5. Wrapping of semi-conductive water swelling tape
6. Metallic screen – copper wires and equalizing tapes (optional fibre optic in steel tube)
7. Wrapping of semi-conductive water swelling tape
8. Longitudinally applied aluminium or copper tape coated with PE copolymer
9. Outer sheath – MDPE, HDPE, LSOH
10. Optional – semi-conductive layer

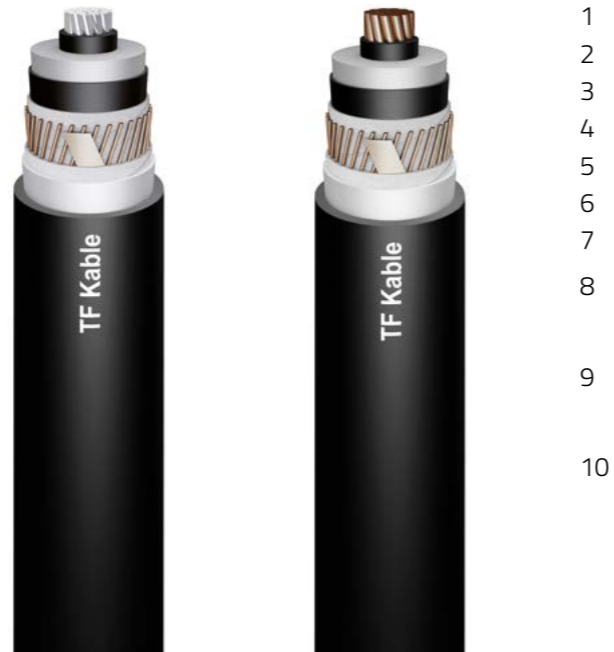

Figure 2: HV XLPE cable with corrugated aluminium sheath

### Description of Figure 2

1. Aluminium (A) or copper conductor (optional watertightness – WTC)
2. Semi-conductive screen extruded on the phase conductor
3. XLPE insulation
4. Semi-conductive screen extruded on insulation
5. Wrapping of semi-conductive water swelling tape
6. Metallic sheath – extruded corrugated aluminium
7. Wrapping of bituminous tape
8. Outer sheath: MDEPE, HDPE, LSOH
9. Optional – semi-conductive layer



Figure 3: HV XLPE cable with lead alloy sheath

### Description of Figure 3

1. Aluminium (A) or copper conductor (optional watertightness – WTC)
2. Semi-conductive screen extruded on the phase conductor
3. XLPE insulation
4. Semi-conductive screen extruded on insulation
5. Wrapping of semi-conductive water swelling tape
6. Metallic sheath – extruded lead alloy
7. Wrapping of separator tape
8. Outer sheath – MDEPE, HDPE, LSOH
9. Optional – semi-conductive layer



Milliken design conductors are applied for cables conductors with cross-sections > 1000 mm<sup>2</sup>

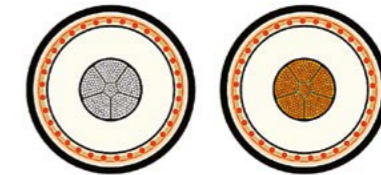

## Selection of cable

High voltage cables are manufactured based on customer specifications and factory standards. Cable structures are based on the requirements of IEC standards:

- IEC 60287 – Calculation of current-carrying capacity of cables (load factor 100%)
- IEC 60853 – Calculation of current-carrying capacity of cables for cyclic load or emergency rating
- IEC 60949 – Calculation of thermally permissible short-circuit currents, taking into account non-adiabatic Heating effects
- IEC 61443 – Maximum short circuit temperature for cables for voltages above 30kV
- IEC 60228 – Conductors of wires and cables

When selecting cable, specialized software is used to simulate the cable system operation.

### Assumption to calculate the transmission capacity

Transmission capacities are calculated based on the following conditions:

#### Direct buried:

- Load factor = 1
- Laying depth 1.0m
- Soil temperature 20°C
- Thermal resistivity of the soil 1.0°C × m/W
- For flat formation distance between the cable axes 2 × D<sub>e</sub>
- For trefoil formation distance between the cable axes 1 × D<sub>e</sub>
- No soil drying
- No thermal proximity

#### In free air:

- Air temperature 35°C
- For flat formation distance between the cable axes 2 × D<sub>e</sub>
- For trefoil formation distance between the cable axes 1 × D<sub>e</sub>
- No thermal proximity
- Cables covered from solar radiation

**HV XLPE cable with  
copper wires screen and  
aluminium laminated foil**



# HV XLPE CABLE WITH COPPER WIRES SCREEN AND ALUMINIUM LAMINATED FOIL

26/45 ÷ 47 (52) kV

XRUHKXS according to ZN-TF-530

2XS(FL)2Y according to IEC 60840

N2XS(FL)2Y according to DIN VDE 0276-632

## COPPER CONDUCTOR

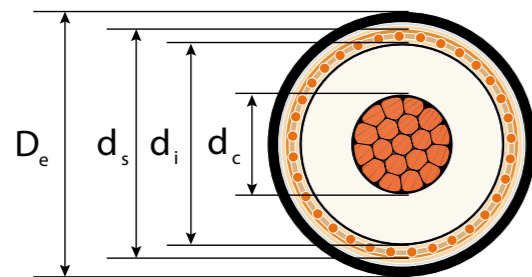

Cross section of conductor	Diameter of conductor	Insulation		Metallic screen		D <sub>e</sub> Outer diameter of cable	Cable weight	Maximum pulling force	Minimal bending radius
		Nominal thickness	Diameter over insulation	Cross section	Diameter over screen				
mm <sup>2</sup>	mm	mm	mm	mm <sup>2</sup>	mm	mm	kg/km	kN	m
95RM	11.5 <sup>+0.20</sup>	9.0	30.7	35	34.5	41	2270	4.8	1.0
120RM	12.8 <sup>+0.25</sup>	9.0	32.0	35	35.8	42	2550	6.0	1.1
150RM	14.4 <sup>+0.20</sup>	9.0	33.6	35	37.4	44	2860	7.5	1.1
185RM	15.8 <sup>+0.40</sup>	9.0	35.0	35	38.8	45	3240	9.3	1.1
240RM	18.5 <sup>+0.30</sup>	9.0	37.7	35	41.5	48	3840	12.0	1.2
300RM	20.5 <sup>+0.20</sup>	9.0	39.7	35	43.5	50	4500	15.0	1.3
400RM	23.6 <sup>+0.30</sup>	9.0	43.2	35	47.4	54	5480	20.0	1.4
500RM	26.4 <sup>+0.40</sup>	9.0	46.0	35	50.2	57	6600	25.0	1.4
630RM	30.3 <sup>+0.40</sup>	9.0	50.1	35	54.3	61	8020	31.5	1.5
800RM	34.7 <sup>+0.40</sup>	9.0	54.5	35	58.7	66	9770	40.0	1.7
1000RM	38.3 <sup>+0.40</sup>	9.0	58.5	35	63.1	71	11910	50.0	1.8
1200RMS	41.6 <sup>+0.80</sup>	9.0	63.8	50	68.4	77	14260	60.0	1.9
1400RMS	45.8 <sup>+0.80</sup>	9.0	68.0	50	72.6	81	16130	70.0	2.0
1600RMS	49.6 <sup>+1.2</sup>	9.0	71.8	50	76.4	85	18300	80.0	2.1

# HV XLPE CABLE WITH COPPER WIRES SCREEN AND ALUMINIUM LAMINATED FOIL

26/45 ÷ 47 (52) kV

1800RMS	53.2 <sup>+1.0</sup>	9.0	75.4	50	80.0	89	20650	90.0	2.2
2000RMS	54.6 <sup>+1.0</sup>	9.0	76.8	50	81.4	91	22200	100.0	2.3
2500RMS	60.0 <sup>+1.0</sup>	9.0	83.2	50	88.2	98	27140	100.0	2.4
3000RMS	68.4 <sup>+1.0</sup>	9.0	91.6	50	96.6	107	33410	100.0	2.7

## Electrical data

D<sub>e</sub> – Cable diameter

Cables in flat formation, the distance between the cable axes = 2 × D<sub>e</sub>



Cables in trefoil formation, the distance between the cable axes = D<sub>e</sub>

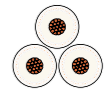

Cross section of conductor	Resistance of conductor 90°C	Electrical field stress at the		Capacitance	Zero reactance	Inductance	
		conductor	insulation screen				
mm <sup>2</sup>	Ω/km	kV/mm		μF/km	Ω/km	Ω/km	
95RM	0.2465	4.65	1.95	0.150	0.086	0.200	0.140
120RM	0.1956	4.50	2.00	0.160	0.082	0.195	0.135
150RM	0.1588	4.35	2.05	0.175	0.077	0.190	0.130
185RM	0.1272	4.25	2.05	0.185	0.074	0.185	0.125
240RM	0.0973	4.10	2.15	0.205	0.068	0.180	0.120
300RM	0.0781	4.00	2.20	0.220	0.065	0.175	0.115
400RM	0.0619	3.85	2.25	0.250	0.061	0.170	0.115
500RM	0.0492	3.75	2.30	0.270	0.058	0.170	0.110
630RM	0.0395	3.65	2.35	0.300	0.054	0.165	0.105
800RM	0.0325	3.60	2.40	0.335	0.050	0.160	0.100
1000RM	0.0275	3.50	2.45	0.365	0.049	0.160	0.100
1200RMS	0.0222	3.45	2.50	0.405	0.048	0.155	0.100
1400RMS	0.0198	3.40	2.50	0.435	0.046	0.155	0.095
1600RMS	0.0182	3.35	2.55	0.465	0.044	0.155	0.095
1800RMS	0.0169	3.35	2.55	0.490	0.043	0.150	0.095
2000RMS	0.0158	3.35	2.55	0.500	0.042	0.150	0.095
2500RMS	0.0140	3.30	2.60	0.550	0.041	0.150	0.090
3000RMS	0.0126	3.25	2.60	0.610	0.039	0.145	0.090

# HV XLPE CABLE WITH COPPER WIRES SCREEN AND ALUMINIUM LAMINATED FOIL

26/45 ÷ 47 (52) kV

XRUHAKXS according to ZN-TF-530

A2XS(FL)2Y according to IEC 60840

NA2XS(FL)2Y according to DIN VDE 0276-632

## ALUMINIUM CONDUCTOR

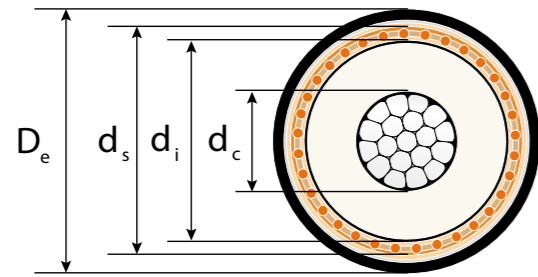

Cross section of conductor	Diameter of conductor	Insulation		Metallic screen		D <sub>e</sub> Outer diameter of cable	Cable weight	Maximum pulling force	Minimal bending radius
		Nominal thickness	Diameter over insulation	Cross section	Diameter over screen				
mm <sup>2</sup>	mm	mm	mm	mm <sup>2</sup>	mm	mm	kg/km	kN	m
95RM	11.3 <sup>+0.20</sup>	9.0	30.5	35	34.3	41	1690	3.3	1.0
120RM	12.5 <sup>+0.20</sup>	9.0	31.7	35	35.5	42	1810	4.2	1.1
150RM	14.1 <sup>+0.30</sup>	9.0	33.3	35	37.1	43	1940	5.3	1.1
185RM	15.8 <sup>+0.20</sup>	9.0	35.0	35	38.8	45	2110	6.5	1.1
240RM	17.9 <sup>+0.10</sup>	9.0	37.1	35	40.9	47	2350	8.4	1.2
300RM	20.0 <sup>+0.30</sup>	9.0	39.2	35	43.0	49	2590	10.5	1.2
400RM	22.9 <sup>+0.30</sup>	9.0	42.5	35	46.7	53	3040	14.0	1.3
500RM	25.7 <sup>+0.40</sup>	9.0	45.3	35	49.5	56	3470	17.5	1.4
630RM	29.3 <sup>+0.50</sup>	9.0	49.1	35	53.3	60	4030	22.1	1.5
800RM	33.0 <sup>+0.50</sup>	9.0	52.8	35	57.0	64	4650	28.0	1.6
1000RM	38.0 <sup>+0.50</sup>	9.0	58.2	35	62.8	71	5570	35.0	1.8
1200RM	42.5 <sup>+0.60</sup>	9.0	62.7	50	67.3	75	6560	42.0	1.9
1200RMS	43.0 <sup>+0.80</sup>	9.0	65.2	50	69.8	78	6840	42.0	2.0
1400RMS	45.1 <sup>+0.80</sup>	9.0	67.3	50	71.9	80	7490	49.0	2.0
1600RMS	48.5 <sup>+1.2</sup>	9.0	70.7	50	75.3	84	8270	56.0	2.1

# HV XLPE CABLE WITH COPPER WIRES SCREEN AND ALUMINIUM LAMINATED FOIL

26/45 ÷ 47 (52) kV

1800RMS	52.7 <sup>+1.0</sup>	9.0	74.9	50	79.5	88	9170	63.0	2.2
2000RMS	54.5 <sup>+1.0</sup>	9.0	76.7	50	81.3	90	9760	70.0	2.3
2500RMS	59.0 <sup>+1.0</sup>	9.0	82.2	50	87.2	97	11270	87.5	2.4
3000RMS	67.0 <sup>+1.0</sup>	9.0	90.2	50	95.2	105	13690	100.0	2.6

## Electrical data

D<sub>e</sub> – Cable diameter

Cables in flat formation, the distance between the cable axes = 2 × D<sub>e</sub>



Cables in trefoil formation, the distance between the cable axes = D<sub>e</sub>

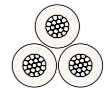

Cross section of conductor	Resistance of conductor 90°C	Electrical field stress at the		Capacitance	Zero reactance	Inductance	
		conductor screen	insulation				
mm <sup>2</sup>	Ω/km	kV/mm		μF/km	Ω/km	Ω/km	
95RM	0.4110	4.70	1.95	0.150	0.087	0.200	0.145
120RM	0.3247	4.55	2.00	0.160	0.083	0.195	0.140
150RM	0.2645	4.40	2.05	0.175	0.078	0.190	0.135
185RM	0.2108	4.25	2.10	0.185	0.074	0.185	0.130
240RM	0.1610	4.15	2.15	0.205	0.069	0.180	0.125
300RM	0.1291	4.00	2.20	0.220	0.065	0.180	0.120
400RM	0.1009	3.90	2.25	0.245	0.062	0.175	0.115
500RM	0.0792	3.80	2.30	0.265	0.058	0.170	0.110
630RM	0.0622	3.70	2.35	0.295	0.055	0.165	0.105
800RM	0.0498	3.60	2.40	0.320	0.052	0.160	0.105
1000RM	0.0408	3.50	2.45	0.360	0.049	0.160	0.100
1200RM	0.0359	3.45	2.45	0.395	0.046	0.155	0.095
1200RMS	0.0319	3.45	2.50	0.415	0.048	0.155	0.095
1400RMS	0.0275	3.40	2.50	0.430	0.047	0.155	0.095
1600RMS	0.0242	3.40	2.55	0.455	0.045	0.155	0.095
1800RMS	0.0216	3.35	2.55	0.485	0.043	0.150	0.095
2000RMS	0.0195	3.35	2.55	0.500	0.042	0.150	0.095
2500RMS	0.0168	3.30	2.60	0.540	0.042	0.150	0.090
3000RMS	0.0130	3.25	2.60	0.600	0.039	0.150	0.090

# HV XLPE CABLE WITH COPPER WIRES SCREEN AND ALUMINIUM LAMINATED FOIL

36/60 ÷ 69 (72.5) kV

XRUHKXS according to ZN-TF-530

2XS(FL)2Y according to IEC 60840

N2XS(FL)2Y according to DIN VDE 0276-632

## COPPER CONDUCTOR

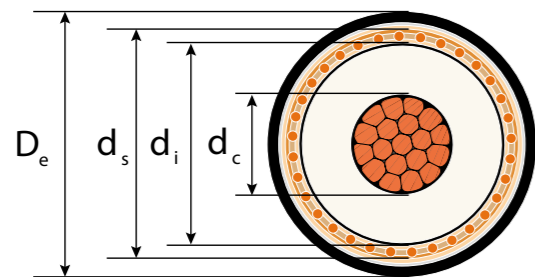

Cross section of conductor	Diameter of conductor	Insulation		Metallic screen		D <sub>e</sub> Outer diameter of cable	Cable weight	Maximum pulling force	Minimal bending radius
		Nominal thickness	Diameter over insulation	Cross section	Diameter over screen				
mm <sup>2</sup>	mm	mm	mm	mm <sup>2</sup>	mm	mm	kg/km	kN	m
120RM	12.8 <sup>+0.25</sup>	10.0	34.0	35	37.8	44	2670	6.0	1.1
150RM	14.4 <sup>+0.20</sup>	10.0	35.6	35	39.4	46	2980	7.5	1.1
185RM	15.8 <sup>+0.40</sup>	10.0	37.0	35	40.8	47	3370	9.3	1.2
240RM	18.5 <sup>+0.30</sup>	10.0	39.7	35	43.5	50	3990	12.0	1.3
300RM	20.5 <sup>+0.20</sup>	10.0	41.7	35	45.5	52	4650	15.0	1.3
400RM	23.6 <sup>+0.30</sup>	10.0	45.2	35	49.4	56	5660	20.0	1.4
500RM	26.4 <sup>+0.40</sup>	10.0	48.0	35	52.2	59	6780	25.0	1.5
630RM	30.3 <sup>+0.40</sup>	10.0	52.1	35	56.3	64	8220	31.5	1.6
800RM	34.7 <sup>+0.40</sup>	10.0	56.5	35	60.7	68	9980	40.0	1.7
1000RM	38.3 <sup>+0.40</sup>	10.0	60.5	35	65.1	73	12140	50.0	1.8
1200RMS	41.6 <sup>+0.80</sup>	10.0	65.8	50	70.4	79	14500	60.0	2.0
1400RMS	45.8 <sup>+0.80</sup>	10.0	70.0	50	74.6	83	16360	70.0	2.1
1600RMS	49.6 <sup>+1.2</sup>	10.0	73.8	50	78.4	87	18580	80.0	2.2
1800RMS	53.2 <sup>+1.0</sup>	10.0	77.4	50	82.0	91	20930	90.0	2.3

# HV XLPE CABLE WITH COPPER WIRES SCREEN AND ALUMINIUM LAMINATED FOIL

36/60 ÷ 69 (72.5) kV

2000RMS	54.6 <sup>+1.0</sup>	10.0	78.8	50	83.4	93	22490	100.0	2.3
2500RMS	60.0 <sup>+1.0</sup>	10.0	85.2	50	90.2	100	27450	100.0	2.5
3000RMS	68.4 <sup>+1.0</sup>	10.0	93.6	50	98.6	109	33750	100.0	2.7

## Electrical data

D<sub>e</sub> – Cable diameter

Cables in flat formation, the distance between the cable axes = 2 × D<sub>e</sub>



Cables in trefoil formation, the distance between the cable axes = D<sub>e</sub>

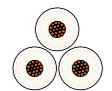

Cross section of conductor	Resistance of conductor 90°C	Electrical field stress at the		Capacitance	Zero reactance	Inductance	
		conductor screen	insulation				
mm <sup>2</sup>	Ω/km	kV/mm		μF/km	Ω/km	Ω/km	
120RM	0.1956	5.80	2.40	0.155	0.085	0.200	0.140
150RM	0.1588	5.60	2.45	0.160	0.080	0.190	0.135
185RM	0.1272	5.45	2.50	0.170	0.077	0.185	0.130
240RM	0.0973	5.25	2.60	0.190	0.071	0.180	0.125
300RM	0.0781	5.10	2.65	0.205	0.067	0.175	0.120
400RM	0.0619	4.90	2.75	0.230	0.064	0.175	0.115
500RM	0.0492	4.80	2.80	0.250	0.060	0.170	0.110
630RM	0.0395	4.65	2.90	0.275	0.056	0.165	0.110
800RM	0.0325	4.55	2.95	0.305	0.052	0.160	0.105
1000RM	0.0275	4.45	3.00	0.335	0.051	0.160	0.100
1200RMS	0.0222	4.35	3.05	0.370	0.050	0.160	0.100
1400RMS	0.0198	4.30	3.10	0.400	0.048	0.155	0.100
1600RMS	0.0182	4.25	3.10	0.425	0.046	0.155	0.095
1800RMS	0.0169	4.20	3.15	0.450	0.044	0.155	0.095
2000RMS	0.0158	4.20	3.15	0.455	0.044	0.150	0.095
2500RMS	0.0140	4.15	3.20	0.500	0.043	0.150	0.095
3000RMS	0.0126	4.10	3.25	0.555	0.040	0.145	0.090

# HV XLPE CABLE WITH COPPER WIRES SCREEN AND ALUMINIUM LAMINATED FOIL

36/60 ÷ 69 (72.5) kV

XRUHAKXS according to ZN-TF-530

A2XS(FL)2Y according to IEC 60840

NA2XS(FL)2Y according to DIN VDE 0276-632

## ALUMINIUM CONDUCTOR

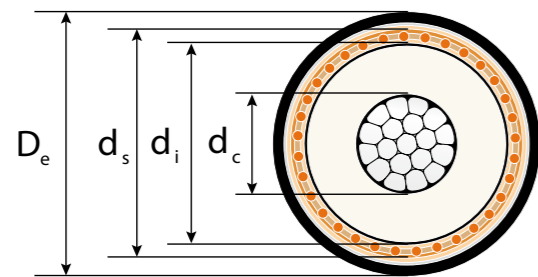

Cross section of conductor	Diameter of conductor	Insulation		Metallic screen		D <sub>e</sub> Outer diameter of cable	Cable weight	Maximum pulling force	Minimal bending radius
		Nominal thickness	Diameter over insulation	Cross section	Diameter over screen				
mm <sup>2</sup>	mm	mm	mm	mm <sup>2</sup>	mm	mm	kg/km	kN	m
120RM	12.5 <sup>+0.20</sup>	10.0	33.7	35	37.5	44	1920	4.2	1.1
150RM	14.1 <sup>+0.30</sup>	10.0	35.3	35	39.1	45	2070	5.3	1.1
185RM	15.8 <sup>+0.20</sup>	10.0	37.0	35	40.8	47	2240	6.5	1.2
240RM	17.9 <sup>+0.10</sup>	10.0	39.1	35	42.9	49	2480	8.4	1.2
300RM	20.0 <sup>+0.30</sup>	10.0	41.2	35	45.0	52	2750	10.5	1.3
400RM	22.9 <sup>+0.30</sup>	10.0	44.5	35	48.7	55	3190	14.0	1.4
500RM	25.7 <sup>+0.40</sup>	10.0	47.3	35	51.5	58	3630	17.5	1.5
630RM	29.3 <sup>+0.50</sup>	10.0	51.1	35	55.3	63	4220	22.1	1.6
800RM	33.0 <sup>+0.50</sup>	10.0	54.8	35	59.0	67	4860	28.0	1.7
1000RM	38.0 <sup>+0.50</sup>	10.0	60.2	35	64.8	73	5800	35.0	1.8
1200RM	42.5 <sup>+0.60</sup>	10.0	64.7	50	69.3	78	6800	42.0	1.9
1200RMS	43.0 <sup>+0.80</sup>	10.0	67.2	50	71.8	80	7070	42.0	2.0
1400RMS	45.1 <sup>+0.80</sup>	10.0	69.3	50	73.9	82	7750	49.0	2.1
1600RMS	48.5 <sup>+1.2</sup>	10.0	72.7	50	77.3	86	8520	56.0	2.2

# HV XLPE CABLE WITH COPPER WIRES SCREEN AND ALUMINIUM LAMINATED FOIL

36/60 ÷ 69 (72.5) kV

1800RMS	52.7 <sup>+1.0</sup>	10.0	76.9	50	81.5	91	9450	63.0	2.3
2000RMS	54.5 <sup>+1.0</sup>	10.0	78.7	50	83.3	92	10020	70.0	2.3
2500RMS	59.0 <sup>+1.0</sup>	10.0	84.2	50	89.2	99	11580	87.5	2.5
3000RMS	67.0 <sup>+1.0</sup>	10.0	92.2	50	97.2	107	13990	100.0	2.7

## Electrical data

D<sub>e</sub> – Cable diameter

Cables in flat formation, the distance between the cable axes = 2 × D<sub>e</sub>



Cables in trefoil formation, the distance between the cable axes = D<sub>e</sub>

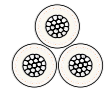

Cross section of conductor	Resistance of conductor 90°C	Electrical field stress at the		Capacitance	Zero reactance	Inductance	
		conductor screen	insulation			Ω/km	Ω/km
mm <sup>2</sup>	Ω/km	kV/mm	kV/mm	μF/km	Ω/km	Ω/km	Ω/km
120RM	0.3247	5.85	2.40	0.150	0.086	0.200	0.140
150RM	0.2645	5.65	2.45	0.160	0.081	0.195	0.135
185RM	0.2108	5.45	2.50	0.175	0.077	0.190	0.130
240RM	0.1610	5.30	2.60	0.190	0.072	0.185	0.125
300RM	0.1291	5.15	2.65	0.200	0.068	0.180	0.120
400RM	0.1009	4.95	2.75	0.225	0.065	0.175	0.115
500RM	0.0792	4.80	2.80	0.245	0.061	0.170	0.115
630RM	0.0622	4.70	2.85	0.270	0.057	0.165	0.110
800RM	0.0498	4.60	2.90	0.295	0.054	0.165	0.105
1000RM	0.0408	4.45	3.00	0.330	0.051	0.160	0.100
1200RM	0.0359	4.40	3.05	0.365	0.048	0.155	0.100
1200RMS	0.0319	4.35	3.05	0.380	0.049	0.160	0.100
1400RMS	0.0275	4.30	3.10	0.395	0.048	0.160	0.100
1600RMS	0.0242	4.25	3.10	0.415	0.047	0.155	0.100
1800RMS	0.0216	4.25	3.15	0.445	0.045	0.155	0.095
2000RMS	0.0195	4.20	3.15	0.455	0.044	0.150	0.095
2500RMS	0.0168	4.15	3.20	0.495	0.043	0.150	0.095
3000RMS	0.0130	4.10	3.20	0.545	0.041	0.150	0.090



# HV XLPE CABLE WITH COPPER WIRES SCREEN AND ALUMINIUM LAMINATED FOIL

64/110 ÷ 115 (123) kV

XRUHKXS according to ZN-TF-530

2XS(FL)2Y according to IEC 60840

N2XS(FL)2Y according to DIN VDE 0276-632

## COPPER CONDUCTOR

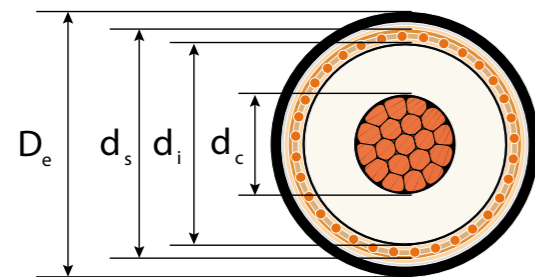

Cross section of conductor	Diameter of conductor	Insulation		Metallic screen		D <sub>e</sub> Outer diameter of cable	Cable weight	Maximum pulling force	Minimal bending radius
		Nominal thickness	Diameter over insulation	Cross section	Diameter over screen				
mm <sup>2</sup>	mm	mm	mm	mm <sup>2</sup>	mm	mm	kg/km	kN	m
150RM	14.4 <sup>+0.20</sup>	18.0	53.4	95	59.2	67	5280	7.5	1.7
185RM	15.8 <sup>+0.40</sup>	17.0	52.2	95	58.0	66	5450	9.3	1.7
240RM	18.5 <sup>+0.30</sup>	16.5	53.5	95	59.3	67	6000	12.0	1.7
300RM	20.5 <sup>+0.20</sup>	15.5	53.5	95	59.3	67	6500	15.0	1.7
400RM	23.6 <sup>+0.30</sup>	14.5	54.6	95	60.4	69	7300	20.0	1.7
500RM	26.4 <sup>+0.40</sup>	14.0	56.4	95	62.2	71	8350	25.0	1.8
630RM	30.3 <sup>+0.40</sup>	14.0	60.9	95	66.7	75	9920	31.5	1.9
800RM	34.7 <sup>+0.40</sup>	14.0	65.3	95	71.1	80	11740	40.0	2.0
1000RM	38.3 <sup>+0.40</sup>	14.0	68.9	95	74.7	84	13880	50.0	2.1
1200RMS	41.6 <sup>+0.80</sup>	14.0	73.8	95	79.6	89	16090	60.0	2.2
1400RMS	45.8 <sup>+0.80</sup>	14.0	78.0	95	83.8	94	18040	70.0	2.3
1600RMS	49.6 <sup>+1.2</sup>	14.0	81.8	95	87.6	98	20290	80.0	2.4
1800RMS	53.2 <sup>+1.0</sup>	14.0	85.4	95	91.2	102	22700	90.0	2.5
2000RMS	54.6 <sup>+1.0</sup>	14.0	86.8	95	92.6	103	24270	100.0	2.6

# HV XLPE CABLE WITH COPPER WIRES SCREEN AND ALUMINIUM LAMINATED FOIL

64/110 ÷ 115 (123) kV

2500RMS	60.0 <sup>+1.0</sup>	14.5	94.2	95	100.4	112	29830	100.0	2.8
3000RMS	68.4 <sup>+1.0</sup>	14.5	102.6	95	108.8	121	35960	100.0	3.0

## Electrical data

D<sub>e</sub> – Cable diameter

Cables in flat formation, the distance between the cable axes = 2 × D<sub>e</sub>



Cables in trefoil formation, the distance between the cable axes = D<sub>e</sub>

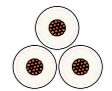

Cross section of conductor	Resistance of conductor 90°C	Electrical field stress at the		Capacitance	Zero reactance	Inductance	
		conductor	insulation screen			μF/km	Ω/km
mm <sup>2</sup>	Ω/km	kV/mm		μF/km	Ω/km	Ω/km	
150RM	0.1588	6.56	2.14	0.119	0.104	0.215	0.155
185RM	0.1272	6.67	2.33	0.127	0.098	0.210	0.150
240RM	0.0973	6.51	2.49	0.135	0.089	0.200	0.140
300RM	0.0781	6.57	2.76	0.154	0.083	0.195	0.135
400RM	0.0619	6.60	3.10	0.176	0.075	0.185	0.130
500RM	0.0492	6.60	3.35	0.195	0.071	0.180	0.125
630RM	0.0395	6.35	3.45	0.220	0.067	0.175	0.120
800RM	0.0325	6.15	3.50	0.240	0.062	0.170	0.115
1000RM	0.0275	6.05	3.60	0.260	0.059	0.170	0.110
1200RMS	0.0222	5.90	3.65	0.280	0.058	0.165	0.110
1400RMS	0.0198	5.80	3.70	0.300	0.055	0.165	0.105
1600RMS	0.0182	5.70	3.75	0.320	0.053	0.160	0.105
1800RMS	0.0169	5.65	3.80	0.340	0.051	0.160	0.100
2000RMS	0.0158	5.60	3.80	0.345	0.050	0.160	0.100
2500RMS	0.0140	5.35	3.70	0.365	0.050	0.160	0.100
3000RMS	0.0126	5.30	3.80	0.405	0.046	0.155	0.095

# HV XLPE CABLE WITH COPPER WIRES SCREEN AND ALUMINIUM LAMINATED FOIL

64/110 ÷ 115 (123) kV

XRUHAKXS according to ZN-TF-530

A2XS(FL)2Y according to IEC 60840

NA2XS(FL)2Y according to DIN VDE 0276-632

## ALUMINIUM CONDUCTOR

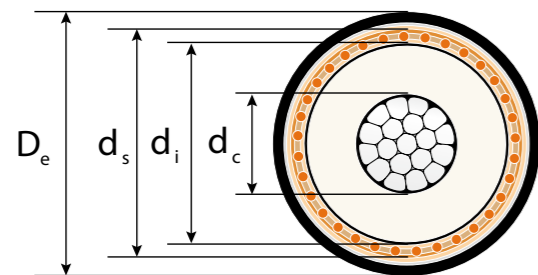

Cross section of conductor	Diameter of conductor	Insulation		Metallic screen		D <sub>e</sub> Outer diameter of cable	Cable weight	Maximum pulling force	Minimal bending radius
		Nominal thickness	Diameter over insulation	Cross section	Diameter over screen				
mm <sup>2</sup>	mm	mm	mm	mm <sup>2</sup>	mm	mm	kg/km	kN	m
150RM	14.1 <sup>+0.30</sup>	18.0	53.1	95	58.9	67	4350	5.3	1.7
185RM	15.8 <sup>+0.20</sup>	17.0	52.2	95	58.0	66	4330	6.5	1.7
240RM	17.9 <sup>+0.10</sup>	16.5	52.9	95	58.7	67	4490	8.4	1.7
300RM	20.0 <sup>+0.30</sup>	15.5	53.0	95	58.8	67	4600	10.5	1.7
400RM	22.9 <sup>+0.30</sup>	14.5	53.9	95	59.7	68	4820	14.0	1.7
500RM	25.7 <sup>+0.40</sup>	14.0	55.7	95	61.5	70	5210	17.5	1.8
630RM	29.3 <sup>+0.50</sup>	14.0	59.9	95	65.7	74	5910	22.1	1.9
800RM	33.0 <sup>+0.50</sup>	14.0	63.6	95	69.4	78	6610	28.0	2.0
1000RM	38.0 <sup>+0.50</sup>	14.0	68.6	95	74.4	84	7540	35.0	2.1
1200RM	42.5 <sup>+0.60</sup>	14.0	73.1	95	78.9	88	8440	42.0	2.2
1200RMS	43.0 <sup>+0.80</sup>	14.0	75.2	95	81.0	91	8710	42.0	2.3
1400RMS	45.1 <sup>+0.80</sup>	14.0	77.3	95	83.1	93	9420	49.0	2.3
1600RMS	48.5 <sup>+1.2</sup>	14.0	80.7	95	86.5	97	10240	56.0	2.4
1800RMS	52.7 <sup>+1.0</sup>	14.0	84.9	95	90.7	101	11200	63.0	2.5

# HV XLPE CABLE WITH COPPER WIRES SCREEN AND ALUMINIUM LAMINATED FOIL

64/110 ÷ 115 (123) kV

2000RMS	54.5 <sup>+1.0</sup>	14.0	86.7	95	92.5	103	11830	70.0	2.6
2500RMS	59.0 <sup>+1.0</sup>	14.5	93.2	95	99.4	110	13610	87.5	2.8
3000RMS	67.0 <sup>+1.0</sup>	14.5	101.2	95	107.4	119	16180	100.0	3.0

## Electrical data

D<sub>e</sub> – Cable diameter

Cables in flat formation, the distance between the cable axes = 2 × D<sub>e</sub>



Cables in trefoil formation, the distance between the cable axes = D<sub>e</sub>

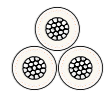

Cross section of conductor	Resistance of conductor 90°C	Electrical field stress at the		Capacitance	Zero reactance	Inductance	
		conductor	insulation				
mm <sup>2</sup>	Ω/km	kV/mm		μF/km	Ω/km	Ω/km	
150RM	0.2645	6.61	2.13	0.118	0.105	0.215	0.160
185RM	0.2108	6.67	2.23	0.127	0.095	0.210	0.150
240RM	0.1610	6.58	2.47	0.130	0.090	0.200	0.145
300RM	0.1291	6.62	2.75	0.152	0.084	0.195	0.135
400RM	0.1009	6.66	3.08	0.172	0.076	0.185	0.130
500RM	0.0792	6.65	3.30	0.195	0.072	0.185	0.125
630RM	0.0622	6.40	3.40	0.215	0.068	0.180	0.120
800RM	0.0498	6.20	3.50	0.230	0.064	0.175	0.115
1000RM	0.0408	6.05	3.60	0.255	0.059	0.170	0.110
1200RM	0.0359	5.90	3.65	0.280	0.056	0.165	0.105
1200RMS	0.0319	5.85	3.70	0.290	0.057	0.165	0.105
1400RMS	0.0275	5.80	3.70	0.300	0.056	0.165	0.105
1600RMS	0.0242	5.70	3.75	0.315	0.054	0.160	0.105
1800RMS	0.0216	5.65	3.80	0.335	0.051	0.160	0.100
2000RMS	0.0195	5.60	3.80	0.345	0.050	0.160	0.100
2500RMS	0.0168	5.35	3.70	0.360	0.050	0.160	0.100
3000RMS	0.0130	5.25	3.75	0.400	0.047	0.155	0.095

# HV XLPE CABLE WITH COPPER WIRES SCREEN AND ALUMINIUM LAMINATED FOIL

76/132 ÷ 138 (145) kV

XRUHKXS according to ZN-TF-530

2XS(FL)2Y according to IEC 60840

N2XS(FL)2Y according to DIN VDE 0276-632

## COPPER CONDUCTOR

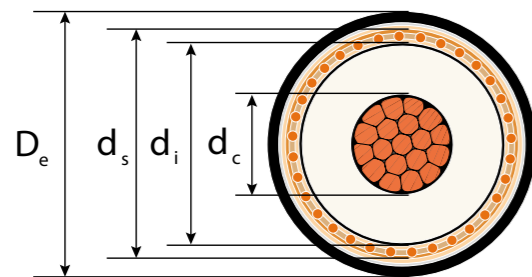

Cross section of conductor	Diameter of conductor	Insulation		Metallic screen		D <sub>e</sub> Outer diameter of cable	Cable weight	Maximum pulling force	Minimal bending radius
		Nominal thickness	Diameter over insulation	Cross section	Diameter over screen				
mm <sup>2</sup>	mm	mm	mm	mm <sup>2</sup>	mm	mm	kg/km	kN	m
185RM	15.8 <sup>+0.40</sup>	18.0	54.8	95	60.6	69	5730	9.3	1.7
240RM	18.5 <sup>+0.30</sup>	17.0	55.5	95	61.3	70	6220	12.0	1.7
300RM	20.5 <sup>+0.20</sup>	16.5	55.9	95	61.7	70	6770	15.0	1.8
400RM	23.6 <sup>+0.30</sup>	16.0	57.6	95	63.4	72	7620	20.0	1.8
500RM	26.4 <sup>+0.40</sup>	16.0	60.4	95	66.2	75	8800	25.0	1.9
630RM	30.3 <sup>+0.40</sup>	16.0	64.9	95	70.7	80	10380	31.5	2.0
800RM	34.7 <sup>+0.40</sup>	16.0	69.3	95	75.1	84	12250	40.0	2.1
1000RM	38.3 <sup>+0.40</sup>	16.0	72.9	95	78.7	88	14390	50.0	2.2
1200RMS	41.6 <sup>+0.80</sup>	16.0	77.8	95	83.6	94	16670	60.0	2.3
1400RMS	45.8 <sup>+0.80</sup>	16.0	82.0	95	87.8	98	18620	70.0	2.5
1600RMS	49.6 <sup>+1.2</sup>	16.0	85.8	95	91.6	102	20910	80.0	2.6
1800RMS	53.2 <sup>+1.0</sup>	16.0	89.4	95	95.2	106	23350	90.0	2.7
2000RMS	54.6 <sup>+1.0</sup>	16.0	90.8	95	96.6	107	24900	100.0	2.7
3000RMS	68.4 <sup>+1.0</sup>	16.0	105.6	95	111.8	124	36520	100.0	3.1

# HV XLPE CABLE WITH COPPER WIRES SCREEN AND ALUMINIUM LAMINATED FOIL

76/132 ÷ 138 (145) kV

2500RMS	60.0 <sup>+1.0</sup>	16.0	97.2	95	103.4	115	30050	100.0	2.9
3000RMS	68.4 <sup>+1.0</sup>	16.0	105.6	95	111.8	124	36520	100.0	3.1

## Electrical data

D<sub>e</sub> – Cable diameter

Cables in flat formation, the distance between the cable axes = 2 × D<sub>e</sub>



Cables in trefoil formation, the distance between the cable axes = D<sub>e</sub>



Cross section of conductor	Resistance of conductor 90°C	Electrical field stress at the		Capacitance	Zero reactance	Inductance	
		conductor	insulation				
mm <sup>2</sup>	Ω/km	kV/mm		μF/km	Ω/km	Ω/km	
185RM	0.1272	7.60	2.60	0.125	0.102	0.215	0.155
240RM	0.0973	7.50	2.90	0.145	0.093	0.205	0.145
300RM	0.0781	7.45	3.05	0.150	0.086	0.195	0.140
400RM	0.0619	7.35	3.30	0.165	0.079	0.190	0.130
500RM	0.0492	7.10	3.35	0.180	0.075	0.185	0.125
630RM	0.0395	6.80	3.45	0.200	0.070	0.180	0.120
800RM	0.0325	6.60	3.55	0.215	0.066	0.175	0.120
1000RM	0.0275	6.45	3.65	0.235	0.062	0.170	0.115
1200RMS	0.0222	6.30	3.70	0.255	0.061	0.170	0.115
1400RMS	0.0198	6.15	3.75	0.270	0.058	0.165	0.110
1600RMS	0.0182	6.10	3.80	0.290	0.056	0.165	0.105
1800RMS	0.0169	6.00	3.85	0.305	0.054	0.160	0.105
2000RMS	0.0158	5.95	3.90	0.310	0.053	0.160	0.105
2500RMS	0.0140	5.85	3.95	0.335	0.051	0.160	0.100
3000RMS	0.0126	5.75	3.95	0.370	0.048	0.155	0.100

# HV XLPE CABLE WITH COPPER WIRES SCREEN AND ALUMINIUM LAMINATED FOIL

76/132 ÷ 138 (145) kV

XRUHAKXS according to ZN-TF-530

A2XS(FL)2Y according to IEC 60840

NA2XS(FL)2Y according to DIN VDE 0276-632

## ALUMINIUM CONDUCTOR

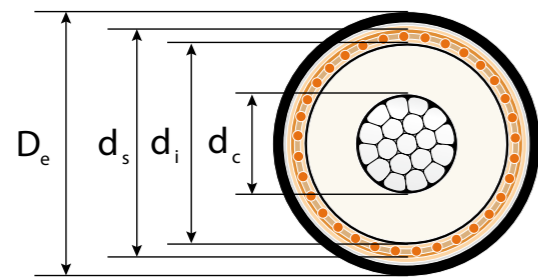

Cross section of conductor	Diameter of conductor	Insulation		Metallic screen		D <sub>e</sub> Outer diameter of cable	Cable weight	Maximum pulling force	Minimal bending radius
		Nominal thickness	Diameter over insulation	Cross section	Diameter over screen				
mm <sup>2</sup>	mm	mm	mm	mm <sup>2</sup>	mm	mm	kg/km	kN	m
185RM	15.8 <sup>+0.20</sup>	18.0	54.8	95	60.6	69	4600	6.5	1.7
240RM	17.9 <sup>+0.10</sup>	17.0	54.9	95	60.7	69	4710	8.4	1.7
300RM	20.0 <sup>+0.30</sup>	16.5	55.4	95	61.2	70	4850	10.5	1.7
400RM	22.9 <sup>+0.30</sup>	16.0	56.9	95	62.7	71	5140	14.0	1.8
500RM	25.7 <sup>+0.40</sup>	16.0	59.7	95	65.5	74	5640	17.5	1.9
630RM	29.3 <sup>+0.50</sup>	16.0	63.9	95	69.7	79	6370	22.1	2.0
800RM	33.0 <sup>+0.50</sup>	16.0	67.6	95	73.4	83	7090	28.0	2.1
1000RM	38.0 <sup>+0.50</sup>	16.0	72.6	95	78.4	88	8050	35.0	2.2
1200RM	42.5 <sup>+0.60</sup>	16.0	77.1	95	82.9	93	9010	42.0	2.3
1200RMS	43.0 <sup>+0.80</sup>	16.0	79.2	95	85.0	95	9270	42.0	2.4
1400RMS	45.1 <sup>+0.80</sup>	16.0	81.3	95	87.1	97	9990	49.0	2.4
1600RMS	48.5 <sup>+1.2</sup>	16.0	84.7	95	90.5	101	10830	56.0	2.5
1800RMS	52.7 <sup>+1.0</sup>	16.0	88.9	95	94.7	105	11850	63.0	2.6
2000RMS	54.5 <sup>+1.0</sup>	16.0	90.7	95	96.5	107	12460	70.0	2.7
3000RMS	67.0 <sup>+1.0</sup>	16.0	104.2	95	110.4	122	16730	100.0	3.1

# HV XLPE CABLE WITH COPPER WIRES SCREEN AND ALUMINIUM LAMINATED FOIL

76/132 ÷ 138 (145) kV

2500RMS	59.0 <sup>+1.0</sup>	16.0	96.2	95	102.4	114	14120	87.5	2.8
3000RMS	67.0 <sup>+1.0</sup>	16.0	104.2	95	110.4	122	16730	100.0	3.1

## Electrical data

D<sub>e</sub> – Cable diameter

Cables in flat formation, the distance between the cable axes = 2 × D<sub>e</sub>



Cables in trefoil formation, the distance between the cable axes = D<sub>e</sub>

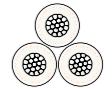

Cross section of conductor	Resistance of conductor 90°C	Electrical field stress at the		Capacitance	Zero reactance	Inductance	
		conductor	insulation screen			Ω/km	
mm <sup>2</sup>	Ω/km	kV/mm		μF/km	Ω/km	Ω/km	
185RM	0.2108	7.60	2.60	0.125	0.102	0.215	0.155
240RM	0.1610	7.55	2.90	0.140	0.094	0.205	0.145
300RM	0.1291	7.50	3.05	0.150	0.088	0.200	0.140
400RM	0.1009	7.40	3.25	0.165	0.080	0.190	0.135
500RM	0.0792	7.15	3.35	0.175	0.076	0.185	0.130
630RM	0.0622	6.90	3.45	0.195	0.072	0.180	0.125
800RM	0.0498	6.70	3.55	0.210	0.067	0.175	0.120
1000RM	0.0408	6.45	3.65	0.230	0.063	0.170	0.115
1200RM	0.0359	6.30	3.70	0.250	0.059	0.170	0.110
1200RMS	0.0319	6.25	3.75	0.260	0.060	0.170	0.110
1400RMS	0.0275	6.20	3.75	0.270	0.059	0.165	0.110
1600RMS	0.0242	6.10	3.80	0.285	0.056	0.165	0.110
1800RMS	0.0216	6.00	3.85	0.300	0.054	0.160	0.105
2000RMS	0.0195	6.00	3.90	0.310	0.053	0.160	0.105
2500RMS	0.0168	5.90	3.95	0.330	0.052	0.160	0.100
3000RMS	0.0130	5.75	3.95	0.365	0.049	0.155	0.100

# HV XLPE CABLE WITH COPPER WIRES SCREEN AND ALUMINIUM LAMINATED FOIL

87/150 ÷ 161 (170) kV

XRUHKXS according to ZN-TF-530

2XS(FL)2Y according to IEC 60840

N2XS(FL)2Y according to DIN VDE 0276-632

## COPPER CONDUCTOR

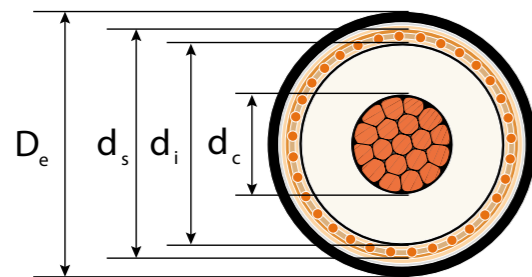

Cross section of conductor	Diameter of conductor	Insulation		Metallic screen		D <sub>e</sub> Outer diameter of cable	Cable weight	Maximum pulling force	Minimal bending radius
		Nominal thickness	Diameter over insulation	Cross section	Diameter over screen				
mm <sup>2</sup>	mm	mm	mm	mm <sup>2</sup>	mm	mm	kg/km	kN	m
240RM	18.5 <sup>+0.30</sup>	21.0	63.5	95	69.3	78	7120	12.0	2.0
300RM	20.5 <sup>+0.20</sup>	20.5	64.3	95	70.1	79	7710	15.0	2.0
400RM	23.6 <sup>+0.30</sup>	19.5	65.0	95	70.8	80	8450	20.0	2.0
500RM	26.4 <sup>+0.40</sup>	19.0	66.8	95	72.6	82	9560	25.0	2.1
630RM	30.3 <sup>+0.40</sup>	19.0	70.9	95	76.7	86	11130	31.5	2.2
800RM	34.7 <sup>+0.40</sup>	19.0	75.3	95	81.1	91	13050	40.0	2.3
1000RM	38.3 <sup>+0.40</sup>	19.0	78.9	95	84.7	95	15220	50.0	2.4
1200RMS	41.6 <sup>+0.80</sup>	19.0	83.8	95	89.6	100	17550	60.0	2.5
1400RMS	45.8 <sup>+0.80</sup>	19.0	88.0	95	93.8	104	19540	70.0	2.6
1600RMS	49.6 <sup>+1.2</sup>	19.0	91.8	95	97.6	109	21880	80.0	2.7
1800RMS	53.2 <sup>+1.0</sup>	19.0	95.4	95	101.2	112	24340	90.0	2.8
2000RMS	54.6 <sup>+1.0</sup>	18.0	94.8	95	100.6	112	25590	100.0	2.8
2500RMS	60.0 <sup>+1.0</sup>	18.0	101.2	95	107.4	119	30740	100.0	3.0
3000RMS	68.4 <sup>+1.0</sup>	18.0	109.6	95	115.8	128	37280	100.0	3.2

# HV XLPE CABLE WITH COPPER WIRES SCREEN AND ALUMINIUM LAMINATED FOIL

87/150 ÷ 161 (170) kV

## Electrical data

D<sub>e</sub> – Cable diameter

Cables in flat formation, the distance between the cable axes = 2 × D<sub>e</sub>



Cables in trefoil formation, the distance between the cable axes = D<sub>e</sub>

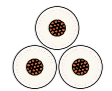

Cross section of conductor	Resistance of conductor 90°C	Electrical field stress at the		Capacitance	Zero reactance	Inductance	
		conductor screen	insulation			μF/km	Ω/km
mm <sup>2</sup>	Ω/km	kV/mm		μF/km	Ω/km	Ω/km	
240RM	0.0973	7.50	2.55	0.125	0.100	0.210	0.150
300RM	0.0781	7.40	2.70	0.130	0.094	0.205	0.145
400RM	0.0619	7.35	2.95	0.145	0.086	0.195	0.140
500RM	0.0492	7.20	3.10	0.160	0.081	0.190	0.135
630RM	0.0395	6.90	3.20	0.175	0.076	0.185	0.125
800RM	0.0325	6.65	3.30	0.190	0.071	0.180	0.120
1000RM	0.0275	6.50	3.40	0.205	0.067	0.175	0.120
1200RMS	0.0222	6.30	3.45	0.225	0.065	0.175	0.115
1400RMS	0.0198	6.20	3.50	0.240	0.062	0.170	0.110
1600RMS	0.0182	6.10	3.55	0.250	0.060	0.170	0.110
1800RMS	0.0169	6.00	3.60	0.265	0.058	0.165	0.110
2000RMS	0.0158	6.20	3.85	0.280	0.056	0.165	0.110
2500RMS	0.0140	6.10	3.95	0.305	0.054	0.160	0.105
3000RMS	0.0126	5.95	3.95	0.335	0.050	0.155	0.100

# HV XLPE CABLE WITH COPPER WIRES SCREEN AND ALUMINIUM LAMINATED FOIL

87/150 ÷ 161 (170) kV

XRUHAKXS according to ZN-TF-530

A2XS(FL)2Y according to IEC 60840

NA2XS(FL)2Y according to DIN VDE 0276-632

## ALUMINIUM CONDUCTOR

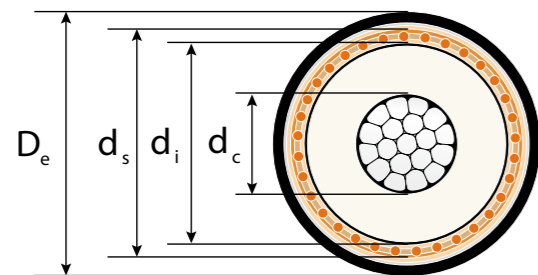

Cross section of conductor	Diameter of conductor	Insulation		Metallic screen		D <sub>e</sub> Outer diameter of cable	Cable weight	Maximum pulling force	Minimal bending radius
		Nominal thickness	Diameter over insulation	Cross section	Diameter over screen				
mm <sup>2</sup>	mm	mm	mm	mm <sup>2</sup>	mm	mm	kg/km	kN	m
240RM	17.9 <sup>+0.10</sup>	21.0	62.9	95	68.7	78	5600	8.4	1.9
300RM	20.0 <sup>+0.30</sup>	20.5	63.8	95	69.6	78	5800	10.5	2.0
400RM	22.9 <sup>+0.30</sup>	19.5	64.3	95	70.1	79	5990	14.0	2.0
500RM	25.7 <sup>+0.40</sup>	19.0	66.1	95	71.9	81	6410	17.5	2.0
630RM	29.3 <sup>+0.50</sup>	19.0	69.9	95	75.7	85	7110	22.1	2.1
800RM	33.0 <sup>+0.50</sup>	19.0	73.6	95	79.4	89	7870	28.0	2.2
1000RM	38.0 <sup>+0.50</sup>	19.0	78.6	95	84.4	94	8880	35.0	2.4
1200RM	42.5 <sup>+0.60</sup>	19.0	83.1	95	88.9	99	9880	42.0	2.5
1200RMS	43.0 <sup>+0.80</sup>	19.0	85.2	95	91.0	101	10160	42.0	2.5
1400RMS	45.1 <sup>+0.80</sup>	19.0	87.3	95	93.1	104	10910	49.0	2.6
1600RMS	48.5 <sup>+1.2</sup>	19.0	90.7	95	96.5	107	11780	56.0	2.7
1800RMS	52.7 <sup>+1.0</sup>	19.0	94.9	95	100.7	112	12840	63.0	2.8
2000RMS	54.5 <sup>+1.0</sup>	18.0	94.7	95	100.5	112	13150	70.0	2.8
2500RMS	59.0 <sup>+1.0</sup>	18.0	100.2	95	106.4	118	14850	87.5	3.0
3000RMS	67.0 <sup>+1.0</sup>	18.0	108.2	95	114.2	127	17510	100.0	3.2

# HV XLPE CABLE WITH COPPER WIRES SCREEN AND ALUMINIUM LAMINATED FOIL

87/150 ÷ 161 (170) kV

## Electrical data

D<sub>e</sub> – Cable diameter

Cables in flat formation, the distance between the cable axes = 2 × D<sub>e</sub>



Cables in trefoil formation, the distance between the cable axes = D<sub>e</sub>

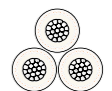

Cross section of conductor	Resistance of conductor 90°C	Electrical field stress at the		Capacitance	Zero reactance	Inductance	
		conductor screen	insulation			μF/km	Ω/km
mm <sup>2</sup>	Ω/km	kV/mm		μF/km	Ω/km	Ω/km	
240RM	0.1610	7.60	2.55	0.125	0.102	0.215	0.155
300RM	0.1291	7.45	2.65	0.130	0.095	0.205	0.150
400RM	0.1009	7.40	2.95	0.145	0.088	0.200	0.140
500RM	0.0792	7.25	3.10	0.160	0.082	0.195	0.135
630RM	0.0622	7.00	3.20	0.170	0.077	0.185	0.130
800RM	0.0498	6.75	3.30	0.185	0.072	0.180	0.125
1000RM	0.0408	6.50	3.40	0.205	0.067	0.175	0.120
1200RM	0.0359	6.35	3.45	0.220	0.064	0.170	0.115
1200RMS	0.0319	6.25	3.50	0.230	0.064	0.175	0.115
1400RMS	0.0275	6.20	3.50	0.235	0.062	0.170	0.115
1600RMS	0.0242	6.10	3.55	0.250	0.060	0.170	0.110
1800RMS	0.0216	6.00	3.60	0.265	0.058	0.165	0.110
2000RMS	0.0195	6.20	3.85	0.280	0.056	0.165	0.105
2500RMS	0.0168	6.10	3.95	0.300	0.054	0.160	0.105
3000RMS	0.0130	6.00	3.95	0.330	0.051	0.160	0.100

# HV XLPE CABLE WITH COPPER WIRES SCREEN AND ALUMINIUM LAMINATED FOIL

127/220 ÷ 230 (245) kV

XRUHKXS according to ZN-TF-530

2XS(FL)2Y according to IEC 62067

## COPPER CONDUCTOR

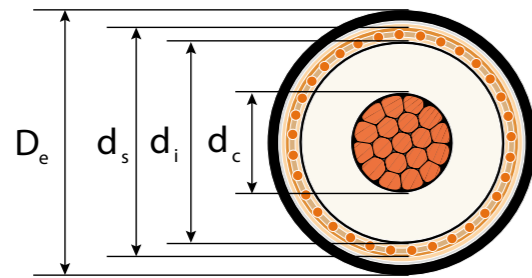

Cross section of conductor	Diameter of conductor	Insulation		Metallic screen		D <sub>e</sub> Outer diameter of cable	Cable weight	Maximum pulling force	Minimal bending radius
		Nominal thickness	Diameter over insulation	Cross section	Diameter over screen				
mm <sup>2</sup>	mm	mm	mm	mm <sup>2</sup>	mm	mm	kg/km	kN	m
400RM	23.6 <sup>+0.30</sup>	24.0	74.8	150	81.4	91	10300	20.0	2.3
500RM	26.4 <sup>+0.40</sup>	23.0	75.4	150	82.0	92	11250	25.0	2.3
630RM	30.3 <sup>+0.40</sup>	22.0	77.5	150	84.1	94	12610	31.5	2.3
800RM	34.7 <sup>+0.40</sup>	22.0	81.3	150	87.9	98	14470	40.0	2.5
1000RM	38.3 <sup>+0.40</sup>	21.0	82.9	150	89.5	100	16400	50.0	2.5
1200RMS	41.6 <sup>+0.80</sup>	21.0	87.8	150	94.4	105	18760	60.0	2.6
1400RMS	45.8 <sup>+0.80</sup>	21.0	92.0	150	98.6	109	20790	70.0	2.7
1600RMS	49.6 <sup>+1.2</sup>	21.0	95.8	150	102.4	113	23120	80.0	2.8
1800RMS	53.2 <sup>+1.0</sup>	21.0	99.4	150	106.0	117	25650	90.0	2.9
2000RMS	54.6 <sup>+1.0</sup>	21.0	100.8	150	107.4	119	27220	100.0	3.0
2500RMS	60.0 <sup>+1.0</sup>	21.5	108.2	150	115.4	127	32710	100.0	3.2
3000RMS	68.4 <sup>+1.0</sup>	21.5	116.6	150	123.8	136	39360	100.0	3.4

# HV XLPE CABLE WITH COPPER WIRES SCREEN AND ALUMINIUM LAMINATED FOIL

127/220 ÷ 230 (245) kV

## Electrical data

D<sub>e</sub> – Cable diameter

Cables in flat formation, the distance between the cable axes = 2 × D<sub>e</sub>



Cables in trefoil formation, the distance between the cable axes = D<sub>e</sub>



Cross section of conductor	Resistance of conductor 90°C	Electrical field stress at the conductor insulation screen		Capacitance	Zero reactance	Inductance	
		kV/mm	kV/mm			μF/km	Ω/km
mm <sup>2</sup>	Ω/km	kV/mm		μF/km	Ω/km	Ω/km	
400RM	0.0619	9.25	3.30	0.130	0.095	0.205	0.150
500RM	0.0492	9.20	3.60	0.145	0.088	0.200	0.140
630RM	0.0395	9.05	3.95	0.160	0.081	0.190	0.135
800RM	0.0325	8.75	4.05	0.175	0.076	0.185	0.125
1000RM	0.0275	8.80	4.35	0.190	0.071	0.180	0.120
1200RMS	0.0222	8.55	4.45	0.205	0.069	0.180	0.120
1400RMS	0.0198	8.35	4.55	0.220	0.065	0.175	0.120
1600RMS	0.0182	8.20	4.60	0.235	0.063	0.170	0.115
1800RMS	0.0169	8.10	4.65	0.245	0.061	0.170	0.115
2000RMS	0.0158	8.05	4.70	0.250	0.060	0.170	0.110
2500RMS	0.0140	7.70	4.65	0.265	0.058	0.170	0.105
3000RMS	0.0126	7.55	4.75	0.290	0.055	0.165	0.105

# HV XLPE CABLE WITH COPPER WIRES SCREEN AND ALUMINIUM LAMINATED FOIL

127/220 ÷ 230 (245) kV

XRUHAKXS according to ZN-TF-530

A2XS(FL)2Y according to IEC 62067

## ALUMINIUM CONDUCTOR

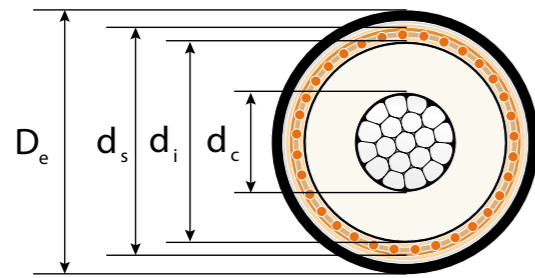

Cross section of conductor	Diameter of conductor	Insulation		Metallic screen		De Outer diameter of cable	Cable weight	Maximum pulling force	Minimal bending radius
		Nominal thickness	Diameter over insulation	Cross section	Diameter over screen				
mm <sup>2</sup>	mm	mm	mm	mm <sup>2</sup>	mm	mm	kg/km	kN	m
400RM	22.9 <sup>+0.30</sup>	24.0	74.1	150	80.7	90	7820	14.0	2.2
500RM	25.7 <sup>+0.40</sup>	23.0	74.7	150	81.3	91	8090	17.5	2.3
630RM	29.3 <sup>+0.50</sup>	22.0	76.5	150	83.1	93	8580	22.1	2.3
800RM	33.0 <sup>+0.50</sup>	22.0	79.6	150	86.2	96	9300	28.0	2.4
1000RM	38.0 <sup>+0.50</sup>	21.0	82.6	150	89.2	99	10050	35.0	2.5
1200RM	42.5 <sup>+0.60</sup>	21.0	87.1	150	93.7	104	11060	42.0	2.6
1200RMS	43.0 <sup>+0.80</sup>	21.0	89.2	150	95.8	106	11380	42.0	2.7
1400RMS	45.1 <sup>+0.80</sup>	21.0	91.3	150	97.9	109	12140	49.0	2.7
1600RMS	48.5 <sup>+1.2</sup>	21.0	94.7	150	101.3	112	13050	56.0	2.8
1800RMS	52.7 <sup>+1.0</sup>	21.0	98.9	150	105.5	117	14110	63.0	2.9
2000RMS	54.5 <sup>+1.0</sup>	21.0	100.7	150	107.3	119	14780	70.0	3.0
2500RMS	59.0 <sup>+1.0</sup>	21.5	107.2	150	114.4	126	16810	87.5	3.2
3000RMS	67.0 <sup>+1.0</sup>	21.5	115.2	150	122.4	135	19540	100.0	3.4

# HV XLPE CABLE WITH COPPER WIRES SCREEN AND ALUMINIUM LAMINATED FOIL

127/220 ÷ 230 (245) kV

## Electrical data

De – Cable diameter

Cables in flat formation, the distance between the cable axes = 2 × De



Cables in trefoil formation, the distance between the cable axes = De

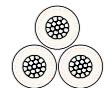

Cross section of conductor	Resistance of conductor 90°C	Electrical field stress at the		Capacitance	Zero reactance	Inductance	
		conductor	insulation			Ω/km	Ω/km
mm <sup>2</sup>	Ω/km	kV/mm		μF/km	Ω/km	Ω/km	
400RM	0.1009	9.35	3.30	0.130	0.096	0.205	0.150
500RM	0.0792	9.30	3.55	0.140	0.090	0.200	0.140
630RM	0.0622	9.15	3.90	0.160	0.083	0.195	0.135
800RM	0.0498	8.90	4.00	0.170	0.078	0.185	0.130
1000RM	0.0408	8.85	4.35	0.190	0.071	0.180	0.120
1200RM	0.0359	8.60	4.45	0.205	0.067	0.175	0.120
1200RMS	0.0319	8.50	4.50	0.210	0.068	0.175	0.120
1400RMS	0.0275	8.40	4.55	0.220	0.066	0.175	0.115
1600RMS	0.0242	8.25	4.60	0.230	0.064	0.170	0.115
1800RMS	0.0216	8.10	4.65	0.245	0.061	0.170	0.110
2000RMS	0.0195	8.05	4.70	0.250	0.060	0.170	0.110
2500RMS	0.0168	7.75	4.65	0.260	0.059	0.165	0.110
3000RMS	0.0130	7.60	4.75	0.285	0.055	0.160	0.105



# HV XLPE CABLE WITH COPPER WIRES SCREEN AND ALUMINIUM LAMINATED FOIL

220/380 ÷ 400 (420) kV

XRUHKXS according to ZN-TF-530

2XS(FL)2Y according to IEC 62067

## COPPER CONDUCTOR

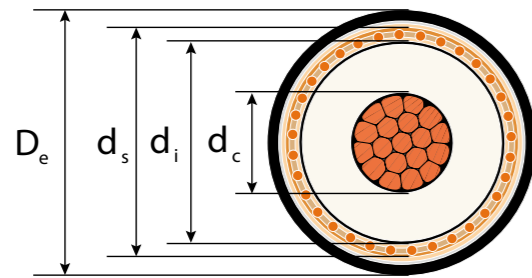

Cross section of conductor	Diameter of conductor	Insulation		Metallic screen		D <sub>e</sub> Outer diameter of cable	Cable weight	Maximum pulling force	Minimal bending radius
		Nominal thickness	Diameter over insulation	Cross section	Diameter over screen				
mm <sup>2</sup>	mm	mm	mm	mm <sup>2</sup>	mm	mm	kg/km	kN	m
630RM	30.3 <sup>+0.40</sup>	32.0	98.5	150	105.7	117	16110	31.5	2.9
800RM	34.7 <sup>+0.40</sup>	31.0	100.9	150	108.1	120	17860	40.0	3.0
1000RM	38.3 <sup>+0.40</sup>	30.0	102.5	150	109.7	121	19850	50.0	3.0
1200RMS	41.6 <sup>+0.80</sup>	28.0	101.8	150	109.0	121	21290	60.0	3.0
1400RMS	45.8 <sup>+0.80</sup>	27.0	104.0	150	111.2	123	23030	70.0	3.1
1600RMS	49.6 <sup>+1.2</sup>	27.0	107.8	150	115.0	127	25480	80.0	3.2
1800RMS	53.2 <sup>+1.0</sup>	27.0	111.4	150	118.6	131	28050	90.0	3.3
2000RMS	54.6 <sup>+1.0</sup>	27.0	112.8	150	120.0	132	29690	100.0	3.3
2500RMS	60.0 <sup>+1.0</sup>	27.0	119.2	150	126.4	139	34970	100.0	3.5
3000RMS	68.4 <sup>+1.0</sup>	27.0	127.6	150	134.8	148	41770	100.0	3.7

# HV XLPE CABLE WITH COPPER WIRES SCREEN AND ALUMINIUM LAMINATED FOIL

220/380 ÷ 400 (420) kV

## Electrical data

D<sub>e</sub> – Cable diameter

Cables in flat formation, the distance between the cable axes = 2 × D<sub>e</sub>



Cables in trefoil formation, the distance between the cable axes = D<sub>e</sub>



Cross section of conductor	Resistance of conductor 90°C	Electrical field stress at the conductor insulation screen		Capacitance	Zero reactance	Inductance	
		kV/mm	μF/km			Ω/km	Ω/km
mm <sup>2</sup>	Ω/km	kV/mm	μF/km	Ω/km	Ω/km	Ω/km	Ω/km
630RM	0.0395	12.20	4.30	0.130	0.096	0.205	0.150
800RM	0.0325	11.90	4.60	0.140	0.089	0.200	0.140
1000RM	0.0275	11.80	4.90	0.155	0.083	0.195	0.135
1200RMS	0.0222	12.05	5.45	0.170	0.078	0.190	0.130
1400RMS	0.0198	12.05	5.80	0.185	0.073	0.185	0.125
1600RMS	0.0182	11.80	5.90	0.195	0.070	0.180	0.120
1800RMS	0.0169	11.60	6.00	0.205	0.068	0.175	0.120
2000RMS	0.0158	11.50	6.00	0.210	0.067	0.175	0.120
2500RMS	0.0140	11.20	6.15	0.225	0.064	0.175	0.115
3000RMS	0.0126	10.90	6.30	0.245	0.060	0.170	0.110

# HV XLPE CABLE WITH COPPER WIRES SCREEN AND ALUMINIUM LAMINATED FOIL

220/380 ÷ 400 (420) kV

XRUHAKXS according to ZN-TF-530

A2XS(FL)2Y according to IEC 62067

## ALUMINIUM CONDUCTOR

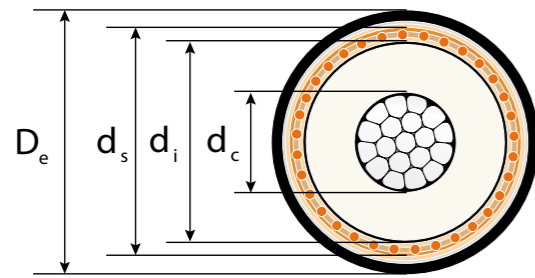

Cross section of conductor	Diameter of conductor	Insulation		Metallic screen		D <sub>e</sub> Outer diameter of cable	Cable weight	Maximum pulling force	Minimal bending radius
		Nominal thickness	Diameter over insulation	Cross section	Diameter over screen				
mm <sup>2</sup>	mm	mm	mm	mm <sup>2</sup>	mm	mm	kg/km	kN	m
630RM	29.3 <sup>+0.50</sup>	32.0	97.5	150	104.7	116	12040	22.1	2.9
800RM	33.0 <sup>+0.50</sup>	31.0	99.2	150	106.4	118	12640	28.0	3.0
1000RM	38.0 <sup>+0.50</sup>	30.0	102.2	150	109.4	121	13490	35.0	3.0
1200RM	42.5 <sup>+0.60</sup>	28.0	102.7	150	109.9	122	13910	42.0	3.0
1200RMS	43.0 <sup>+0.80</sup>	28.0	103.2	150	110.4	122	13950	42.0	3.1
1400RMS	45.1 <sup>+0.80</sup>	27.0	103.3	150	110.5	122	14370	49.0	3.1
1600RMS	48.5 <sup>+1.2</sup>	27.0	106.7	150	113.9	126	15340	56.0	3.1
1800RMS	52.7 <sup>+1.0</sup>	27.0	110.9	150	118.1	130	16540	63.0	3.2
2000RMS	54.5 <sup>+1.0</sup>	27.0	112.7	150	119.9	132	17210	70.0	3.3
2500RMS	59.0 <sup>+1.0</sup>	27.0	118.2	150	125.4	138	19010	87.5	3.5
3000RMS	67.0 <sup>+1.0</sup>	27.0	126.2	150	133.4	147	21920	100.0	3.7

# HV XLPE CABLE WITH COPPER WIRES SCREEN AND ALUMINIUM LAMINATED FOIL

220/380 ÷ 400 (420) kV

## Electrical data

D<sub>e</sub> – Cable diameter

Cables in flat formation, the distance between the cable axes = 2 × D<sub>e</sub>



Cables in trefoil formation, the distance between the cable axes = D<sub>e</sub>

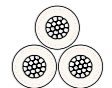

Cross section of conductor	Resistance of conductor 90°C	Electrical field stress at the		Capacitance	Zero reactance	Inductance	
		conductor screen	insulation				
mm <sup>2</sup>	Ω/km	kV/mm		μF/km	Ω/km	Ω/km	
630RM	0.0622	12.30	4.25	0.125	0.097	0.205	0.150
800RM	0.0498	12.10	4.55	0.140	0.091	0.200	0.145
1000RM	0.0408	11.80	4.90	0.155	0.084	0.195	0.135
1200RM	0.0359	12.00	5.45	0.170	0.077	0.185	0.130
1200RMS	0.0319	11.95	5.45	0.170	0.076	0.185	0.130
1400RMS	0.0275	12.10	5.80	0.180	0.074	0.180	0.125
1600RMS	0.0242	11.85	5.85	0.190	0.071	0.180	0.120
1800RMS	0.0216	11.60	5.95	0.200	0.068	0.175	0.120
2000RMS	0.0195	11.50	6.00	0.205	0.067	0.175	0.115
2500RMS	0.0168	11.25	6.10	0.220	0.065	0.170	0.115
3000RMS	0.0130	10.95	6.25	0.240	0.061	0.170	0.110

# HV XLPE CABLE WITH COPPER WIRES SCREEN AND ALUMINIUM LAMINATED FOIL

290/500 (550) kV

XRUHKXS according to ZN-TF-530

2XS(FL)2Y according to IEC 62067

## COPPER CONDUCTOR

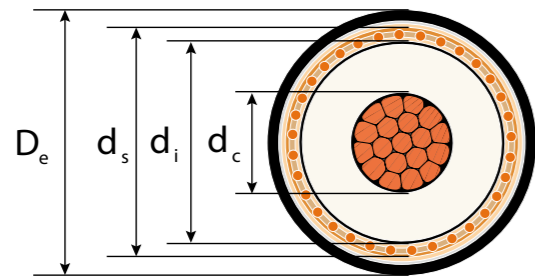

Cross section of conductor	Diameter of conductor	Insulation		Metallic screen		D <sub>e</sub> Outer diameter of cable	Cable weight	Maximum pulling force	Minimal bending radius
		Nominal thickness	Diameter over insulation	Cross section	Diameter over screen				
mm <sup>2</sup>	mm	mm	mm	mm <sup>2</sup>	mm	mm	kg/km	kN	m
1600RMS	49.6 <sup>+1.2</sup>	32.0	119.8	150	128.0	141	28210	80.0	3.5
1800RMS	53.2 <sup>+1.0</sup>	31.0	121.4	150	129.6	143	30450	90.0	3.6
2000RMS	54.6 <sup>+1.0</sup>	31.0	122.8	150	131.0	144	32080	100.0	3.6
2500RMS	60.0 <sup>+1.0</sup>	30.0	126.2	150	134.4	148	36810	100.0	3.7
3000RMS	68.4 <sup>+1.0</sup>	30.0	134.6	150	142.8	157	43680	100.0	3.9

## Electrical data

D<sub>e</sub> – Cable diameter

Cables in flat formation, the distance between the cable axes = 2 × D<sub>e</sub>



Cables in trefoil formation, the distance between the cable axes = D<sub>e</sub>

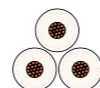

# HV XLPE CABLE WITH COPPER WIRES SCREEN AND ALUMINIUM LAMINATED FOIL

290/500 (550) kV

Cross section of conductor	Resistance of conductor 90°C	Electrical field stress at the		Capacitance	Zero reactance	Inductance	
		conductor screen	insulation				
mm <sup>2</sup>	Ω/km	kV/mm		μF/km	Ω/km	Ω/km	
1600RMS	0.0182	13.65	6.35	0.175	0.077	0.185	0.130
1800RMS	0.0169	13.70	6.70	0.190	0.073	0.185	0.125
2000RMS	0.0158	13.60	6.75	0.190	0.072	0.180	0.125
2500RMS	0.0140	13.60	7.15	0.210	0.068	0.180	0.120
3000RMS	0.0126	13.20	7.35	0.230	0.063	0.175	0.115

# HV XLPE CABLE WITH COPPER WIRES SCREEN AND ALUMINIUM LAMINATED FOIL

290/500 (550) kV

XRUHAKXS according to ZN-TF-530

A2XS(FL)2Y according to IEC 62067

## ALUMINIUM CONDUCTOR

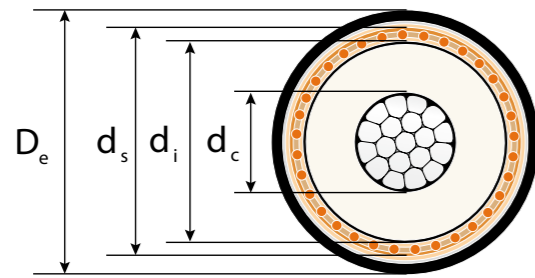

Cross section of conductor	Diameter of conductor	Insulation		Metallic screen		D <sub>e</sub> Outer diameter of cable	Cable weight	Maximum pulling force	Minimal bending radius
		Nominal thickness	Diameter over insulation	Cross section	Diameter over screen				
mm <sup>2</sup>	mm	mm	mm	mm <sup>2</sup>	mm	mm	kg/km	kN	m
1600RMS	48.5 <sup>+1.2</sup>	32.0	118.7	150	126.9	140	18090	56.0	3.5
1800RMS	52.7 <sup>+1.0</sup>	31.0	120.9	150	129.1	142	18930	63.0	3.6
2000RMS	54.5 <sup>+1.0</sup>	31.0	122.7	150	130.9	144	19630	70.0	3.6
2500RMS	59.0 <sup>+1.0</sup>	30.0	125.2	150	133.4	147	20830	87.5	3.7
3000RMS	67.0 <sup>+1.0</sup>	30.0	133.2	150	141.4	155	23860	100.0	3.9

## Electrical data

D<sub>e</sub> – Cable diameter

Cables in flat formation, the distance between the cable axes = 2 × D<sub>e</sub>



Cables in trefoil formation, the distance between the cable axes = D<sub>e</sub>

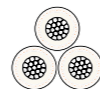

# HV XLPE CABLE WITH COPPER WIRES SCREEN AND ALUMINIUM LAMINATED FOIL

290/500 (550) kV

Cross section of conductor	Resistance of conductor 90°C	Electrical field stress at the		Capacitance	Zero reactance	Inductance	
		conductor screen	insulation			μF/km	Ω/km
mm <sup>2</sup>	Ω/km	kV/mm		μF/km	Ω/km	Ω/km	
1600RMS	0.0242	13.70	6.35	0.175	0.078	0.185	0.130
1800RMS	0.0216	13.70	6.70	0.185	0.074	0.185	0.125
2000RMS	0.0195	13.60	6.75	0.190	0.072	0.180	0.125
2500RMS	0.0168	13.65	7.15	0.205	0.069	0.180	0.120
3000RMS	0.0130	13.25	7.30	0.225	0.064	0.175	0.115



**HV XLPE cable with  
corrugated aluminium  
sheath**

# HV XLPE CABLE WITH CORRUGATED ALUMINIUM SHEATH

26/45 ÷ 47 (52) kV

2X(F)KLD2Y according to IEC 60840

N2X(F)KLD2Y according to DIN VDE 0276-632

COPPER CONDUCTOR

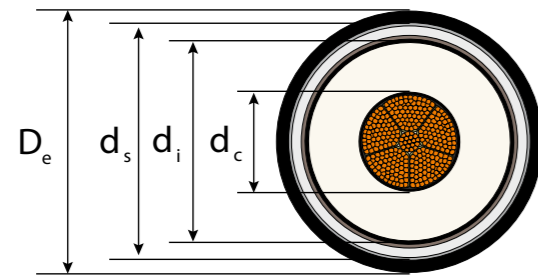

Cross section of conductor	Diameter of conductor	Insulation		Metallic screen		D <sub>e</sub> Outer diameter of cable	Cable weight	Maximum pulling force	Minimal bending radius
		Nominal thickness	Diameter over insulation	Cross section	Diameter over screen				
mm <sup>2</sup>	mm	mm	mm	mm <sup>2</sup>	mm	mm	kg/km	kN	m
400RM	23.6 <sup>+0.30</sup>	9.0	43.2	370	67.0	76	7110	20.0	1.9
500RM	26.4 <sup>+0.40</sup>	9.0	46.0	385	69.8	78	8130	25.0	2.0
630RM	30.3 <sup>+0.40</sup>	9.0	50.1	410	73.9	82	9670	31.5	2.0
800RM	34.7 <sup>+0.40</sup>	9.0	54.5	440	78.3	87	11550	40.0	2.2
1000RM	38.3 <sup>+0.40</sup>	9.0	58.5	470	83.7	93	13870	50.0	2.3
1200RMS	41.6 <sup>+0.80</sup>	9.0	63.8	505	88.8	98	16190	60.0	2.5
1400RMS	45.8 <sup>+0.80</sup>	9.0	68.0	530	93.0	103	18190	70.0	2.6
1600RMS	49.6 <sup>+1.2</sup>	9.0	71.8	555	96.8	107	20470	80.0	2.7
1800RMS	53.2 <sup>+1.0</sup>	9.0	75.4	580	101.4	112	22990	90.0	2.8
2000RMS	54.6 <sup>+1.0</sup>	9.0	76.8	590	102.8	113	24550	100.0	2.8
2500RMS	60.0 <sup>+1.0</sup>	9.0	83.2	630	109.6	121	29730	100.0	3.0
3000RMS	68.4 <sup>+1.0</sup>	9.0	91.6	690	119.4	131	36300	100.0	3.3

# HV XLPE CABLE WITH CORRUGATED ALUMINIUM SHEATH

26/45 ÷ 47 (52) kV

## Electrical data

D<sub>e</sub> – Cable diameter

Cables in flat formation, the distance between the cable axes = 2 × D<sub>e</sub>



Cables in trefoil formation, the distance between the cable axes = D<sub>e</sub>



Cross section of conductor	Resistance of conductor 90°C	Electrical field stress at the conductor insulation screen		Capacitance	Zero reactance	Inductance	
		kV/mm	μF/km			Ω/km	Ω/km
mm <sup>2</sup>	Ω/km	kV/mm	μF/km	Ω/km	Ω/km	Ω/km	Ω/km
400RM	0.0619	3.85	2.25	0.250	0.078	0.195	0.135
500RM	0.0492	3.75	2.30	0.270	0.073	0.190	0.130
630RM	0.0395	3.65	2.35	0.300	0.068	0.185	0.125
800RM	0.0325	3.60	2.40	0.335	0.063	0.180	0.120
1000RM	0.0275	3.50	2.45	0.365	0.062	0.175	0.120
1200RMS	0.0222	3.45	2.50	0.405	0.060	0.175	0.115
1400RMS	0.0198	3.40	2.50	0.435	0.056	0.170	0.115
1600RMS	0.0182	3.35	2.55	0.465	0.054	0.170	0.110
1800RMS	0.0169	3.35	2.55	0.490	0.053	0.170	0.110
2000RMS	0.0158	3.35	2.55	0.500	0.052	0.165	0.110
2500RMS	0.0140	3.30	2.60	0.550	0.050	0.160	0.105
3000RMS	0.0126	3.25	2.60	0.610	0.048	0.160	0.105

# HV XLPE CABLE WITH CORRUGATED ALUMINIUM SHEATH

26/45 ÷ 47 (52) kV

A2X(F)KLD2Y according to IEC 60840

NA2X(F)KLD2Y according to DIN VDE 0276-632

## ALUMINIUM CONDUCTOR

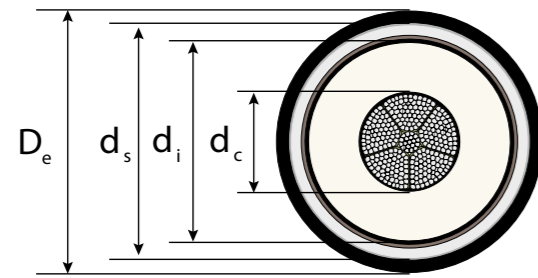

Cross section of conductor	Diameter of conductor	Insulation		Metallic screen		D <sub>e</sub> Outer diameter of cable	Cable weight	Maximum pulling force	Minimal bending radius
		Nominal thickness	Diameter over insulation	Cross section	Diameter over screen				
mm <sup>2</sup>	mm	mm	mm	mm <sup>2</sup>	mm	mm	kg/km	kN	m
400RM	22.9 <sup>+0.30</sup>	9.0	42.5	365	66.3	74	4450	14.0	1.9
500RM	25.7 <sup>+0.40</sup>	9.0	45.3	380	69.1	77	4960	17.5	1.9
630RM	29.3 <sup>+0.50</sup>	9.0	49.1	405	72.9	81	5650	22.1	2.0
800RM	33.0 <sup>+0.50</sup>	9.0	52.8	430	76.6	85	6380	28.0	2.1
1000RM	38.0 <sup>+0.50</sup>	9.0	58.2	470	83.4	92	7500	35.0	2.3
1200RM	42.5 <sup>+0.60</sup>	9.0	62.7	495	87.7	97	8460	42.0	2.4
1200RMS	43.0 <sup>+0.80</sup>	9.0	65.2	510	90.2	100	8820	42.0	2.5
1400RMS	45.1 <sup>+0.80</sup>	9.0	67.3	525	92.3	102	9560	49.0	2.6
1600RMS	48.5 <sup>+1.2</sup>	9.0	70.7	545	95.7	106	10410	56.0	2.6
1800RMS	52.7 <sup>+1.0</sup>	9.0	74.9	575	100.9	111	11490	63.0	2.8
2000RMS	54.5 <sup>+1.0</sup>	9.0	76.7	590	102.7	113	12110	70.0	2.8
2500RMS	59.0 <sup>+1.0</sup>	9.0	82.2	625	108.6	119	13800	87.5	3.0
3000RMS	67.0 <sup>+1.0</sup>	9.0	90.2	680	118.0	130	16550	100.0	3.2

# HV XLPE CABLE WITH CORRUGATED ALUMINIUM SHEATH

26/45 ÷ 47 (52) kV

## Electrical data

D<sub>e</sub> – Cable diameter

Cables in flat formation, the distance between the cable axes = 2 × D<sub>e</sub>



Cables in trefoil formation, the distance between the cable axes = D<sub>e</sub>



Cross section of conductor	Resistance of conductor 90°C	Electrical field stress at the		Capacitance	Zero reactance	Inductance	
		conductor	insulation screen			μF/km	Ω/km
mm <sup>2</sup>	Ω/km	kV/mm		μF/km	Ω/km	Ω/km	
400RM	0.1009	3.90	2.25	0.245	0.079	0.195	0.135
500RM	0.0792	3.80	2.30	0.265	0.074	0.190	0.130
630RM	0.0622	3.70	2.35	0.295	0.069	0.185	0.125
800RM	0.0498	3.60	2.40	0.320	0.066	0.180	0.120
1000RM	0.0408	3.50	2.45	0.360	0.062	0.175	0.120
1200RM	0.0359	3.45	2.45	0.395	0.059	0.175	0.115
1200RMS	0.0319	3.45	2.50	0.415	0.058	0.175	0.115
1400RMS	0.0275	3.40	2.50	0.430	0.057	0.170	0.115
1600RMS	0.0242	3.40	2.55	0.455	0.056	0.170	0.110
1800RMS	0.0216	3.35	2.55	0.485	0.054	0.170	0.110
2000RMS	0.0195	3.35	2.55	0.500	0.053	0.165	0.110
2500RMS	0.0168	3.30	2.60	0.540	0.052	0.165	0.105
3000RMS	0.0130	3.25	2.60	0.600	0.048	0.160	0.105

# HV XLPE CABLE WITH CORRUGATED ALUMINIUM SHEATH

36/60 ÷ 69 (72.5) kV

2X(F)KLD2Y according to IEC 60840

N2X(F)KLD2Y according to DIN VDE 0276-632

COPPER CONDUCTOR

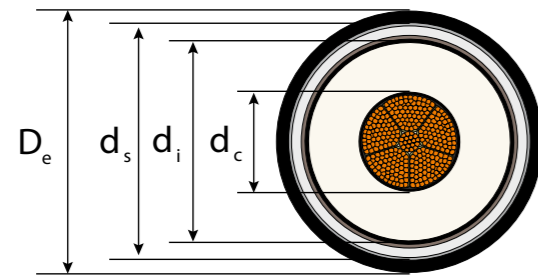

Cross section of conductor	Diameter of conductor	Insulation		Metallic screen		D <sub>e</sub> Outer diameter of cable	Cable weight	Maximum pulling force	Minimal bending radius
		Nominal thickness	Diameter over insulation	Cross section	Diameter over screen				
mm <sup>2</sup>	mm	mm	mm	mm <sup>2</sup>	mm	mm	kg/km	kN	m
300RM	20.5 <sup>+0.20</sup>	10.0	41.7	355	65.1	73	6040	15.0	1.8
400RM	23.6 <sup>+0.30</sup>	10.0	45.2	380	69.0	77	7150	20.0	1.9
500RM	26.4 <sup>+0.40</sup>	10.0	48.0	400	71.8	80	8350	25.0	2.0
630RM	30.3 <sup>+0.40</sup>	10.0	52.1	425	75.9	85	9830	31.5	2.1
800RM	34.7 <sup>+0.40</sup>	10.0	56.5	455	81.3	90	11850	40.0	2.3
1000RM	38.3 <sup>+0.40</sup>	10.0	60.5	485	85.7	95	14130	50.0	2.4
1200RMS	41.6 <sup>+0.80</sup>	10.0	65.8	515	90.8	100	16490	60.0	2.5
1400RMS	45.8 <sup>+0.80</sup>	10.0	70.0	540	95.0	105	18510	70.0	2.6
1600RMS	49.6 <sup>+1.2</sup>	10.0	73.8	570	99.8	110	20840	80.0	2.8
1800RMS	53.2 <sup>+1.0</sup>	10.0	77.4	590	103.4	114	23300	90.0	2.9
2000RMS	54.6 <sup>+1.0</sup>	10.0	78.8	600	104.8	115	24900	100.0	2.9
2500RMS	60.0 <sup>+1.0</sup>	10.0	85.2	645	111.6	123	30060	100.0	3.1
3000RMS	68.4 <sup>+1.0</sup>	10.0	93.6	700	121.4	133	36700	100.0	3.3

# HV XLPE CABLE WITH CORRUGATED ALUMINIUM SHEATH

36/60 ÷ 69 (72.5) kV

## Electrical data

D<sub>e</sub> – Cable diameter

Cables in flat formation, the distance between the cable axes = 2 × D<sub>e</sub>



Cables in trefoil formation, the distance between the cable axes = D<sub>e</sub>



Cross section of conductor	Resistance of conductor 90°C	Electrical field stress at the		Capacitance	Zero reactance	Inductance	
		conductor	insulation				
mm <sup>2</sup>	Ω/km	kV/mm		μF/km	Ω/km	Ω/km	
300RM	0.0781	5.10	2.65	0.205	0.086	0.200	0.145
400RM	0.0619	4.90	2.75	0.230	0.080	0.195	0.140
500RM	0.0492	4.80	2.80	0.250	0.075	0.190	0.135
630RM	0.0395	4.65	2.90	0.275	0.070	0.185	0.130
800RM	0.0325	4.55	2.95	0.305	0.066	0.180	0.125
1000RM	0.0275	4.45	3.00	0.335	0.064	0.180	0.120
1200RMS	0.0222	4.35	3.05	0.370	0.061	0.175	0.120
1400RMS	0.0198	4.30	3.10	0.400	0.059	0.175	0.115
1600RMS	0.0182	4.25	3.10	0.425	0.057	0.170	0.115
1800RMS	0.0169	4.20	3.15	0.450	0.054	0.170	0.110
2000RMS	0.0158	4.20	3.15	0.455	0.053	0.170	0.110
2500RMS	0.0140	4.15	3.20	0.500	0.051	0.165	0.110
3000RMS	0.0126	4.10	3.25	0.555	0.048	0.160	0.105



# HV XLPE CABLE WITH CORRUGATED ALUMINIUM SHEATH

36/60 ÷ 69 (72.5) kV

A2X(F)KLD2Y according to IEC 60840

NA2X(F)KLD2Y according to DIN VDE 0276-632

## ALUMINIUM CONDUCTOR

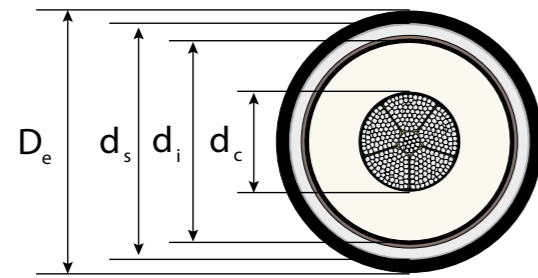

Cross section of conductor	Diameter of conductor	Insulation		Metallic screen		D <sub>e</sub> Outer diameter of cable	Cable weight	Maximum pulling force	Minimal bending radius
		Nominal thickness	Diameter over insulation	Cross section	Diameter over screen				
mm <sup>2</sup>	mm	mm	mm	mm <sup>2</sup>	mm	mm	kg/km	kN	m
300RM	20.0 <sup>+0.30</sup>	10.0	41.2	355	64.6	72	4130	10.5	1.8
400RM	22.9 <sup>+0.30</sup>	10.0	44.5	375	68.3	76	4680	14.0	1.9
500RM	25.7 <sup>+0.40</sup>	10.0	47.3	395	71.1	79	5200	17.5	2.0
630RM	29.3 <sup>+0.50</sup>	10.0	51.1	420	74.9	83	5880	22.1	2.1
800RM	33.0 <sup>+0.50</sup>	10.0	54.8	455	79.6	88	6680	28.0	2.2
1000RM	38.0 <sup>+0.50</sup>	10.0	60.2	480	84.4	95	7790	35.0	2.4
1200RM	42.5 <sup>+0.60</sup>	10.0	64.7	510	89.7	99	8770	42.0	2.5
1200RMS	43.0 <sup>+0.80</sup>	10.0	67.2	525	92.2	102	9130	42.0	2.6
1400RMS	45.1 <sup>+0.80</sup>	10.0	69.3	540	94.3	104	9840	49.0	2.6
1600RMS	48.5 <sup>+1.2</sup>	10.0	72.7	560	98.7	109	10780	56.0	2.7
1800RMS	52.7 <sup>+1.0</sup>	10.0	76.9	590	102.9	113	11800	63.0	2.8
2000RMS	54.5 <sup>+1.0</sup>	10.0	78.7	600	104.7	115	12460	70.0	2.9
2500RMS	59.0 <sup>+1.0</sup>	10.0	84.2	635	110.6	122	14170	87.5	3.0
3000RMS	67.0 <sup>+1.0</sup>	10.0	92.2	690	120.0	132	16910	100.0	3.3

# HV XLPE CABLE WITH CORRUGATED ALUMINIUM SHEATH

36/60 ÷ 69 (72.5) kV

## Electrical data

D<sub>e</sub> – Cable diameter

Cables in flat formation, the distance between the cable axes = 2 × D<sub>e</sub>



Cables in trefoil formation, the distance between the cable axes = D<sub>e</sub>



Cross section of conductor	Resistance of conductor 90°C	Electrical field stress at the		Capacitance	Zero reactance	Inductance	
		conductor	insulation screen				
mm <sup>2</sup>	Ω/km	kV/mm		μF/km	Ω/km	Ω/km	
300RM	0.1291	5.15	2.65	0.200	0.086	0.200	0.145
400RM	0.1009	4.95	2.75	0.225	0.080	0.195	0.140
500RM	0.0792	4.80	2.80	0.245	0.075	0.190	0.135
630RM	0.0622	4.70	2.85	0.270	0.071	0.185	0.130
800RM	0.0498	4.60	2.90	0.295	0.068	0.185	0.125
1000RM	0.0408	4.45	3.00	0.330	0.062	0.180	0.120
1200RM	0.0359	4.40	3.05	0.365	0.059	0.175	0.115
1200RMS	0.0319	4.35	3.05	0.380	0.061	0.175	0.115
1400RMS	0.0275	4.30	3.10	0.395	0.059	0.175	0.115
1600RMS	0.0242	4.25	3.10	0.415	0.057	0.170	0.115
1800RMS	0.0216	4.25	3.15	0.445	0.054	0.170	0.110
2000RMS	0.0195	4.20	3.15	0.455	0.053	0.170	0.110
2500RMS	0.0168	4.15	3.20	0.495	0.052	0.165	0.110
3000RMS	0.0130	4.10	3.20	0.545	0.050	0.165	0.105

# HV XLPE CABLE WITH CORRUGATED ALUMINIUM SHEATH

64/110 ÷ 115 (123) kV

2X(F)KLD2Y according to IEC 60840

N2X(F)KLD2Y according to DIN VDE 0276-632

COPPER CONDUCTOR

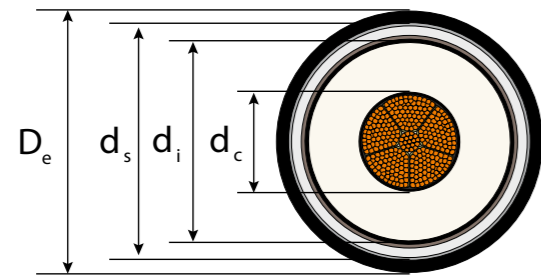

Cross section of conductor	Diameter of conductor	Insulation		Metallic screen		D <sub>e</sub> Outer diameter of cable	Cable weight	Maximum pulling force	Minimal bending radius
		Nominal thickness	Diameter over insulation	Cross section	Diameter over screen				
mm <sup>2</sup>	mm	mm	mm	mm <sup>2</sup>	mm	mm	kg/km	kN	m
240RM	18.5 <sup>+0.30</sup>	16.5	53.5	435	77.7	86	7040	12.0	2.2
300RM	20.5 <sup>+0.20</sup>	15.5	53.5	435	77.7	86	7550	15.0	2.2
400RM	23.6 <sup>+0.30</sup>	14.5	54.6	445	78.8	88	8380	20.0	2.2
500RM	26.4 <sup>+0.40</sup>	14.0	56.4	455	81.6	91	9530	25.0	2.2
630RM	30.3 <sup>+0.40</sup>	14.0	60.9	485	85.9	95	11190	31.5	2.4
800RM	34.7 <sup>+0.40</sup>	14.0	65.3	515	90.3	100	13160	40.0	2.5
1000RM	38.3 <sup>+0.40</sup>	14.0	68.9	535	93.9	104	15380	50.0	2.6
1200RMS	41.6 <sup>+0.80</sup>	14.0	73.8	570	99.8	110	17790	60.0	2.8
1400RMS	45.8 <sup>+0.80</sup>	14.0	78.0	595	104.0	115	19870	70.0	2.9
1600RMS	49.6 <sup>+1.2</sup>	14.0	81.8	620	107.8	119	22210	80.0	3.0
1800RMS	53.2 <sup>+1.0</sup>	14.0	85.4	640	111.4	122	24720	90.0	3.1
2000RMS	54.6 <sup>+1.0</sup>	14.0	86.8	650	112.8	124	26340	100.0	3.1
2500RMS	60.0 <sup>+1.0</sup>	14.5	94.2	705	122.0	134	31880	100.0	3.3
3000RMS	68.4 <sup>+1.0</sup>	14.5	102.6	755	130.2	143	38550	100.0	3.6

# HV XLPE CABLE WITH CORRUGATED ALUMINIUM SHEATH

64/110 ÷ 115 (123) kV

## Electrical data

D<sub>e</sub> – Cable diameter

Cables in flat formation, the distance between the cable axes = 2 × D<sub>e</sub>



Cables in trefoil formation, the distance between the cable axes = D<sub>e</sub>



Cross section of conductor	Resistance of conductor 90°C	Electrical field stress at the		Capacitance	Zero reactance	Inductance	
		conductor	insulation screen				
mm <sup>2</sup>	Ω/km	kV/mm		μF/km	Ω/km	Ω/km	
240RM	0.0973	6.65	2.60	0.145	0.103	0.215	0.160
300RM	0.0781	6.75	2.90	0.160	0.096	0.210	0.150
400RM	0.0619	6.80	3.25	0.180	0.089	0.200	0.145
500RM	0.0492	6.60	3.35	0.195	0.083	0.200	0.140
630RM	0.0395	6.35	3.45	0.220	0.078	0.195	0.135
800RM	0.0325	6.15	3.50	0.240	0.073	0.185	0.130
1000RM	0.0275	6.05	3.60	0.260	0.070	0.185	0.125
1200RMS	0.0222	5.90	3.65	0.280	0.068	0.180	0.125
1400RMS	0.0198	5.80	3.70	0.300	0.064	0.180	0.120
1600RMS	0.0182	5.70	3.75	0.320	0.061	0.175	0.120
1800RMS	0.0169	5.65	3.80	0.340	0.059	0.175	0.115
2000RMS	0.0158	5.60	3.80	0.345	0.058	0.170	0.115
2500RMS	0.0140	5.35	3.70	0.365	0.056	0.170	0.115
3000RMS	0.0126	5.30	3.80	0.405	0.053	0.165	0.110

# HV XLPE CABLE WITH CORRUGATED ALUMINIUM SHEATH

64/110 ÷ 115 (123) kV

A2X(F)KLD2Y according to IEC 60840

NA2X(F)KLD2Y according to DIN VDE 0276-632

## ALUMINIUM CONDUCTOR

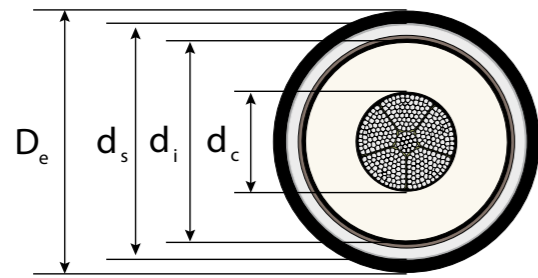

Cross section of conductor	Diameter of conductor	Insulation		Metallic screen		D <sub>e</sub> Outer diameter of cable	Cable weight	Maximum pulling force	Minimal bending radius
		Nominal thickness	Diameter over insulation	Cross section	Diameter over screen				
mm <sup>2</sup>	mm	mm	mm	mm <sup>2</sup>	mm	mm	kg/km	kN	m
240RM	17.9 <sup>+0.10</sup>	16.5	52.9	435	77.1	86	5510	8.4	2.1
300RM	20.0 <sup>+0.30</sup>	15.5	53.0	435	77.2	86	5630	10.5	2.2
400RM	22.9 <sup>+0.30</sup>	14.5	53.9	440	78.1	87	5750	14.0	2.2
500RM	25.7 <sup>+0.40</sup>	14.0	55.7	455	80.9	90	6380	17.5	2.3
630RM	29.3 <sup>+0.50</sup>	14.0	59.9	480	84.9	94	7000	22.1	2.4
800RM	33.0 <sup>+0.50</sup>	14.0	63.6	500	88.6	98	7960	28.0	2.5
1000RM	38.0 <sup>+0.50</sup>	14.0	68.6	535	93.6	103	9030	35.0	2.6
1200RM	42.5 <sup>+0.60</sup>	14.0	73.1	565	99.1	109	10120	42.0	2.7
1200RMS	43.0 <sup>+0.80</sup>	14.0	75.2	580	101.2	112	10450	42.0	2.8
1400RMS	45.1 <sup>+0.80</sup>	14.0	77.3	590	103.3	114	11190	49.0	2.8
1600RMS	48.5 <sup>+1.2</sup>	14.0	80.7	615	106.7	118	12140	56.0	2.9
1800RMS	52.7 <sup>+1.0</sup>	14.0	84.9	640	110.9	122	13220	63.0	3.1
2000RMS	54.5 <sup>+1.0</sup>	14.0	86.7	650	112.7	124	13900	70.0	3.1
2500RMS	59.0 <sup>+1.0</sup>	14.5	93.2	700	121.0	133	15970	87.5	3.3
3000RMS	67.0 <sup>+1.0</sup>	14.5	101.2	750	128.8	141	18720	100.0	3.5

# HV XLPE CABLE WITH CORRUGATED ALUMINIUM SHEATH

64/110 ÷ 115 (123) kV

## Electrical data

D<sub>e</sub> – Cable diameter

Cables in flat formation, the distance between the cable axes = 2 × D<sub>e</sub>



Cables in trefoil formation, the distance between the cable axes = D<sub>e</sub>



Cross section of conductor	Resistance of conductor 90°C	Electrical field stress at the conductor insulation screen		Capacitance	Zero reactance	Inductance	
		kV/mm	μF/km			Ω/km	Ω/km
mm <sup>2</sup>	Ω/km	kV/mm	μF/km	Ω/km	Ω/km	Ω/km	Ω/km
240RM	0.1610	6.58	2.47	0.136	0.104	0.220	0.160
300RM	0.1291	6.62	2.75	0.152	0.097	0.210	0.155
400RM	0.1009	6.66	3.08	0.173	0.089	0.205	0.145
500RM	0.0792	6.65	3.30	0.195	0.085	0.200	0.140
630RM	0.0622	6.40	3.40	0.215	0.080	0.195	0.135
800RM	0.0498	6.20	3.50	0.230	0.074	0.190	0.130
1000RM	0.0408	6.05	3.60	0.255	0.070	0.185	0.125
1200RM	0.0359	5.90	3.65	0.280	0.066	0.180	0.120
1200RMS	0.0319	5.85	3.70	0.290	0.065	0.180	0.120
1400RMS	0.0275	5.80	3.70	0.300	0.064	0.180	0.120
1600RMS	0.0242	5.70	3.75	0.315	0.062	0.175	0.120
1800RMS	0.0216	5.65	3.80	0.335	0.059	0.175	0.115
2000RMS	0.0195	5.60	3.80	0.345	0.058	0.170	0.115
2500RMS	0.0168	5.35	3.70	0.360	0.057	0.170	0.115
3000RMS	0.0130	5.25	3.75	0.400	0.056	0.170	0.110

# HV XLPE CABLE WITH CORRUGATED ALUMINIUM SHEATH

76/132 ÷ 138 (145) kV

2X(F)KLD2Y according to IEC 60840

N2X(F)KLD2Y according to DIN VDE 0276-632

COPPER CONDUCTOR

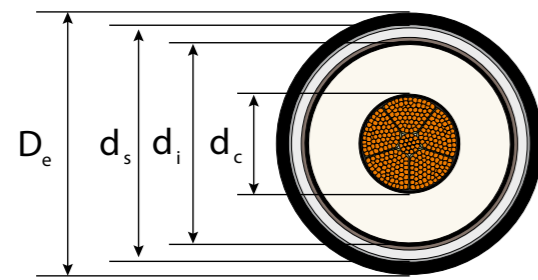

Cross section of conductor	Diameter of conductor	Insulation		Metallic screen		D <sub>e</sub> Outer diameter of cable	Cable weight	Maximum pulling force	Minimal bending radius
		Nominal thickness	Diameter over insulation	Cross section	Diameter over screen				
mm <sup>2</sup>	mm	mm	mm	mm <sup>2</sup>	mm	mm	kg/km	kN	m
240RM	18.5 <sup>+0.30</sup>	17.0	55.5	450	80.7	90	7380	12.0	2.2
300RM	20.5 <sup>+0.20</sup>	16.5	55.9	455	81.1	90	7930	15.0	2.3
400RM	23.6 <sup>+0.30</sup>	16.0	57.6	465	82.8	92	8810	20.0	2.3
500RM	26.4 <sup>+0.40</sup>	16.0	60.4	480	85.4	95	10060	25.0	2.4
630RM	30.3 <sup>+0.40</sup>	16.0	64.9	510	89.9	100	11790	31.5	2.5
800RM	34.7 <sup>+0.40</sup>	16.0	69.3	540	94.3	104	13760	40.0	2.6
1000RM	38.3 <sup>+0.40</sup>	16.0	72.9	565	98.9	109	16070	50.0	2.7
1200RMS	41.6 <sup>+0.80</sup>	16.0	77.8	595	103.8	114	18480	60.0	2.9
1400RMS	45.8 <sup>+0.80</sup>	16.0	82.0	620	108.0	119	20550	70.0	3.0
1600RMS	49.6 <sup>+1.2</sup>	16.0	85.8	645	111.8	123	22920	80.0	3.1
1800RMS	53.2 <sup>+1.0</sup>	16.0	89.4	670	116.8	128	25550	90.0	3.2
2000RMS	54.6 <sup>+1.0</sup>	16.0	90.8	680	118.2	130	27180	100.0	3.3
2500RMS	60.0 <sup>+1.0</sup>	16.0	97.2	725	124.8	137	32480	100.0	3.4
3000RMS	68.4 <sup>+1.0</sup>	16.0	105.6	780	134.4	147	39250	100.0	3.7

# HV XLPE CABLE WITH CORRUGATED ALUMINIUM SHEATH

76/132 ÷ 138 (145) kV

## Electrical data

D<sub>e</sub> – Cable diameter

Cables in flat formation, the distance between the cable axes = 2 × D<sub>e</sub>



Cables in trefoil formation, the distance between the cable axes = D<sub>e</sub>



Cross section of conductor	Resistance of conductor 90°C	Electrical field stress at the		Capacitance	Zero reactance	Inductance	
		conductor	insulation screen				
mm <sup>2</sup>	Ω/km	kV/mm		μF/km	Ω/km	Ω/km	
240RM	0.0973	7.50	2.90	0.145	0.106	0.220	0.160
300RM	0.0781	7.45	3.05	0.150	0.100	0.215	0.155
400RM	0.0619	7.35	3.30	0.165	0.092	0.205	0.150
500RM	0.0492	7.10	3.35	0.180	0.086	0.200	0.145
630RM	0.0395	6.80	3.45	0.200	0.081	0.195	0.140
800RM	0.0325	6.60	3.55	0.215	0.076	0.190	0.130
1000RM	0.0275	6.45	3.65	0.235	0.073	0.185	0.130
1200RMS	0.0222	6.30	3.70	0.255	0.070	0.185	0.125
1400RMS	0.0198	6.15	3.75	0.270	0.066	0.180	0.125
1600RMS	0.0182	6.10	3.80	0.290	0.064	0.180	0.120
1800RMS	0.0169	6.00	3.85	0.305	0.063	0.175	0.120
2000RMS	0.0158	5.95	3.90	0.310	0.062	0.175	0.115
2500RMS	0.0140	5.85	3.95	0.335	0.058	0.175	0.115
3000RMS	0.0126	5.75	3.95	0.370	0.055	0.170	0.110

# HV XLPE CABLE WITH CORRUGATED ALUMINIUM SHEATH

76/132 ÷ 138 (145) kV

A2X(F)KLD2Y according to IEC 60840

NA2X(F)KLD2Y according to DIN VDE 0276-632

## ALUMINIUM CONDUCTOR

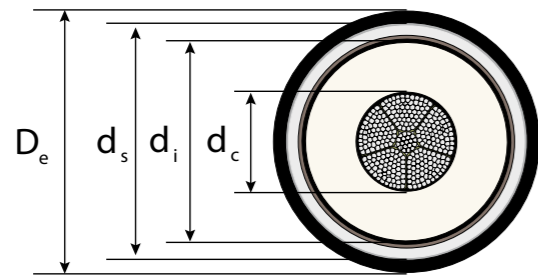

Cross section of conductor	Diameter of conductor	Insulation		Metallic screen		D <sub>e</sub> Outer diameter of cable	Cable weight	Maximum pulling force	Minimal bending radius
		Nominal thickness	Diameter over insulation	Cross section	Diameter over screen				
mm <sup>2</sup>	mm	mm	mm	mm <sup>2</sup>	mm	mm	kg/km	kN	m
240RM	17.9 <sup>+0.10</sup>	17.0	54.9	450	80.1	89	5820	8.4	2.2
300RM	20.0 <sup>+0.30</sup>	16.5	55.4	450	80.6	89	5980	10.5	2.2
400RM	22.9 <sup>+0.30</sup>	16.0	56.9	460	82.1	91	6330	14.0	2.3
500RM	25.7 <sup>+0.40</sup>	16.0	59.7	480	84.7	94	6900	17.5	2.4
630RM	29.3 <sup>+0.50</sup>	16.0	63.9	505	88.9	98	7720	22.1	2.5
800RM	33.0 <sup>+0.50</sup>	16.0	67.6	525	92.6	102	8580	28.0	2.6
1000RM	38.0 <sup>+0.50</sup>	16.0	72.6	560	98.6	109	9720	35.0	2.7
1200RM	42.5 <sup>+0.60</sup>	16.0	77.1	590	103.1	114	10770	42.0	2.8
1200RMS	43.0 <sup>+0.80</sup>	16.0	79.2	605	105.2	116	11120	42.0	2.9
1400RMS	45.1 <sup>+0.80</sup>	16.0	81.3	615	107.3	118	11900	49.0	3.0
1600RMS	48.5 <sup>+1.2</sup>	16.0	84.7	640	110.7	123	12700	56.0	3.1
1800RMS	52.7 <sup>+1.0</sup>	16.0	88.9	670	116.3	128	14040	63.0	3.2
2000RMS	54.5 <sup>+1.0</sup>	16.0	90.7	680	118.1	130	14740	70.0	3.2
2500RMS	59.0 <sup>+1.0</sup>	16.0	96.2	715	123.8	136	16560	87.5	3.4
3000RMS	67.0 <sup>+1.0</sup>	16.0	104.2	770	132.6	145	19440	100.0	3.6

# HV XLPE CABLE WITH CORRUGATED ALUMINIUM SHEATH

76/132 ÷ 138 (145) kV

## Electrical data

D<sub>e</sub> – Cable diameter

Cables in flat formation, the distance between the cable axes = 2 × D<sub>e</sub>



Cables in trefoil formation, the distance between the cable axes = D<sub>e</sub>



Cross section of conductor	Resistance of conductor 90°C	Electrical field stress at the		Capacitance	Zero reactance	Inductance	
		conductor screen	insulation				
mm <sup>2</sup>	Ω/km	kV/mm		μF/km	Ω/km	Ω/km	
240RM	0.1610	7.55	2.90	0.140	0.107	0.220	0.165
300RM	0.1291	7.50	3.05	0.150	0.100	0.215	0.155
400RM	0.1009	7.40	3.25	0.165	0.093	0.210	0.150
500RM	0.0792	7.15	3.35	0.175	0.087	0.200	0.145
630RM	0.0622	6.90	3.45	0.195	0.082	0.195	0.140
800RM	0.0498	6.70	3.55	0.210	0.077	0.190	0.135
1000RM	0.0408	6.45	3.65	0.220	0.072	0.185	0.130
1200RM	0.0359	6.30	3.70	0.250	0.070	0.185	0.125
1200RMS	0.0319	6.25	3.75	0.260	0.068	0.185	0.125
1400RMS	0.0275	6.20	3.75	0.270	0.067	0.180	0.125
1600RMS	0.0242	6.10	3.80	0.285	0.065	0.180	0.120
1800RMS	0.0216	6.00	3.85	0.300	0.063	0.175	0.120
2000RMS	0.0195	6.00	3.90	0.310	0.061	0.175	0.115
2500RMS	0.0168	5.90	3.95	0.330	0.059	0.175	0.115
3000RMS	0.0130	5.75	3.95	0.365	0.055	0.170	0.110

# HV XLPE CABLE WITH CORRUGATED ALUMINIUM SHEATH

87/150 ÷ 161 (170) kV

2X(F)KLD2Y according to IEC 60840

N2X(F)KLD2Y according to DIN VDE 0276-632

COPPER CONDUCTOR

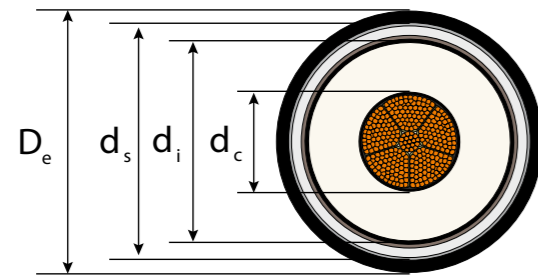

Cross section of conductor	Diameter of conductor	Insulation		Metallic screen		D <sub>e</sub> Outer diameter of cable	Cable weight	Maximum pulling force	Minimal bending radius
		Nominal thickness	Diameter over insulation	Cross section	Diameter over screen				
mm <sup>2</sup>	mm	mm	mm	mm <sup>2</sup>	mm	mm	kg/km	kN	m
240RM	18.5 <sup>+0.30</sup>	21.0	63.5	500	88.5	98	8460	12.0	2.5
300RM	20.5 <sup>+0.20</sup>	20.5	64.3	505	89.3	99	9110	15.0	2.5
400RM	23.6 <sup>+0.30</sup>	19.5	65.0	510	90.0	100	9870	20.0	2.5
500RM	26.4 <sup>+0.40</sup>	19.0	66.8	520	91.8	101	10820	25.0	2.5
630RM	30.3 <sup>+0.40</sup>	19.0	70.9	550	95.9	106	12710	31.5	2.7
800RM	34.7 <sup>+0.40</sup>	19.0	75.3	580	101.3	112	14790	40.0	2.8
1000RM	38.3 <sup>+0.40</sup>	19.0	78.9	600	104.9	116	17070	50.0	2.9
1200RMS	41.6 <sup>+0.80</sup>	19.0	83.8	630	109.8	121	19530	60.0	3.0
1400RMS	45.8 <sup>+0.80</sup>	19.0	88.0	660	114.0	125	21640	70.0	3.1
1600RMS	49.6 <sup>+1.2</sup>	19.0	91.8	685	119.2	131	24150	80.0	3.3
1800RMS	53.2 <sup>+1.0</sup>	19.0	95.4	710	122.8	135	26720	90.0	3.4
2000RMS	54.6 <sup>+1.0</sup>	18.0	94.8	705	122.2	134	27950	100.0	3.4
2500RMS	60.0 <sup>+1.0</sup>	18.0	101.2	750	128.8	141	33290	100.0	3.5
3000RMS	68.4 <sup>+1.0</sup>	18.0	109.6	805	138.4	151	40170	100.0	3.8

# HV XLPE CABLE WITH CORRUGATED ALUMINIUM SHEATH

87/150 ÷ 161 (170) kV

## Electrical data

D<sub>e</sub> – Cable diameter

Cables in flat formation, the distance between the cable axes = 2 × D<sub>e</sub>



Cables in trefoil formation, the distance between the cable axes = D<sub>e</sub>



Cross section of conductor	Resistance of conductor 90°C	Electrical field stress at the		Capacitance	Zero reactance	Inductance	
		conductor	insulation screen			Flat formation	Trefoil formation
mm <sup>2</sup>	Ω/km	kV/mm		μF/km	Ω/km	Ω/km	
240RM	0.0973	7.50	2.55	0.125	0.112	0.225	0.165
300RM	0.0781	7.40	2.70	0.130	0.105	0.220	0.160
400RM	0.0619	7.35	2.95	0.145	0.097	0.210	0.155
500RM	0.0492	7.20	3.10	0.160	0.091	0.205	0.145
630RM	0.0395	6.90	3.20	0.175	0.085	0.200	0.140
800RM	0.0325	6.65	3.30	0.190	0.081	0.195	0.135
1000RM	0.0275	6.50	3.40	0.205	0.076	0.190	0.130
1200RMS	0.0222	6.30	3.45	0.225	0.074	0.190	0.130
1400RMS	0.0198	6.20	3.50	0.240	0.070	0.185	0.125
1600RMS	0.0182	6.10	3.55	0.250	0.068	0.180	0.125
1800RMS	0.0169	6.00	3.60	0.265	0.065	0.180	0.120
2000RMS	0.0158	6.20	3.85	0.280	0.063	0.175	0.120
2500RMS	0.0140	6.10	3.95	0.305	0.061	0.175	0.115
3000RMS	0.0126	5.95	3.95	0.335	0.058	0.170	0.115

# HV XLPE CABLE WITH CORRUGATED ALUMINIUM SHEATH

87/150 ÷ 161 (170) kV

A2X(F)KLD2Y according to IEC 60840

NA2X(F)KLD2Y according to DIN VDE 0276-632

## ALUMINIUM CONDUCTOR

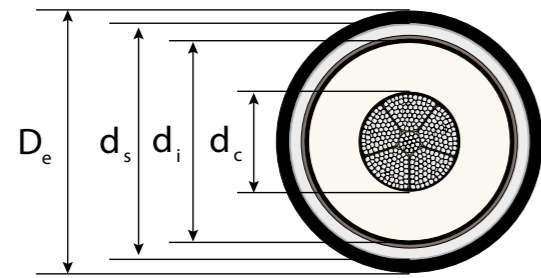

Cross section of conductor	Diameter of conductor	Insulation		Metallic screen		D <sub>e</sub> Outer diameter of cable	Cable weight	Maximum pulling force	Minimal bending radius
		Nominal thickness	Diameter over insulation	Cross section	Diameter over screen				
mm <sup>2</sup>	mm	mm	mm	mm <sup>2</sup>	mm	mm	kg/km	kN	m
240RM	17.9 <sup>+0.10</sup>	21.0	62.9	500	87.9	97	6930	8.4	2.4
300RM	20.0 <sup>+0.30</sup>	20.5	63.8	500	88.8	98	7150	10.5	2.5
400RM	22.9 <sup>+0.30</sup>	19.5	64.3	505	89.3	99	7380	14.0	2.5
500RM	25.7 <sup>+0.40</sup>	19.0	66.1	515	91.1	101	7820	17.5	2.5
630RM	29.3 <sup>+0.50</sup>	19.0	69.9	540	94.9	105	8630	22.1	2.6
800RM	33.0 <sup>+0.50</sup>	19.0	73.6	570	99.6	110	9560	28.0	2.8
1000RM	38.0 <sup>+0.50</sup>	19.0	78.6	600	104.6	115	10720	35.0	2.9
1200RM	42.5 <sup>+0.60</sup>	19.0	83.1	630	109.1	120	11810	42.0	3.0
1200RMS	43.0 <sup>+0.80</sup>	19.0	85.2	640	111.2	122	12180	42.0	3.1
1400RMS	45.1 <sup>+0.80</sup>	19.0	87.3	655	113.3	125	12990	49.0	3.1
1600RMS	48.5 <sup>+1.2</sup>	19.0	90.7	680	118.1	130	14050	56.0	3.2
1800RMS	52.7 <sup>+1.0</sup>	19.0	94.9	705	122.3	134	15200	63.0	3.4
2000RMS	54.5 <sup>+1.0</sup>	18.0	94.7	705	122.1	134	15500	70.0	3.4
2500RMS	59.0 <sup>+1.0</sup>	18.0	100.2	740	127.8	140	17370	87.5	3.5
3000RMS	67.0 <sup>+1.0</sup>	18.0	108.2	795	137.0	150	20320	100.0	3.8

# HV XLPE CABLE WITH CORRUGATED ALUMINIUM SHEATH

87/150 ÷ 161 (170) kV

## Electrical data

D<sub>e</sub> – Cable diameter

Cables in flat formation, the distance between the cable axes = 2 × D<sub>e</sub>



Cables in trefoil formation, the distance between the cable axes = D<sub>e</sub>



Cross section of conductor	Resistance of conductor 90°C	Electrical field stress at the		Capacitance	Zero reactance	Inductance	
		conductor	insulation screen				
mm <sup>2</sup>	Ω/km	kV/mm		μF/km	Ω/km	Ω/km	
240RM	0.1610	7.60	2.55	0.125	0.113	0.225	0.170
300RM	0.1291	7.45	2.65	0.130	0.107	0.220	0.165
400RM	0.1009	7.40	2.95	0.145	0.100	0.215	0.155
500RM	0.0792	7.25	3.10	0.160	0.099	0.205	0.150
630RM	0.0622	7.00	3.20	0.170	0.086	0.200	0.145
800RM	0.0498	6.75	3.30	0.185	0.082	0.195	0.140
1000RM	0.0408	6.50	3.40	0.205	0.075	0.190	0.135
1200RM	0.0359	6.35	3.45	0.220	0.074	0.185	0.130
1200RMS	0.0319	6.25	3.50	0.230	0.073	0.185	0.130
1400RMS	0.0275	6.20	3.50	0.235	0.072	0.185	0.125
1600RMS	0.0242	6.10	3.55	0.250	0.069	0.185	0.125
1800RMS	0.0216	6.00	3.60	0.265	0.067	0.180	0.120
2000RMS	0.0195	6.20	3.85	0.280	0.065	0.175	0.120
2500RMS	0.0168	6.10	3.95	0.300	0.062	0.175	0.115
3000RMS	0.0130	6.00	3.95	0.330	0.058	0.170	0.115

# HV XLPE CABLE WITH CORRUGATED ALUMINIUM SHEATH

127/220 ÷ 230 (245) kV

2X(F)KLD2Y according to IEC 62067

COPPER CONDUCTOR

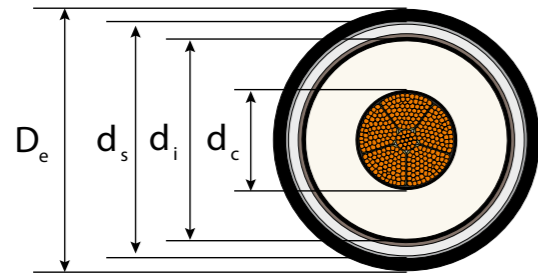

Cross section of conductor	Diameter of conductor	Insulation		Metallic screen		D <sub>e</sub> Outer diameter of cable	Cable weight	Maximum pulling force	Minimal bending radius
		Nominal thickness	Diameter over insulation	Cross section	Diameter over screen				
mm <sup>2</sup>	mm	mm	mm	mm <sup>2</sup>	mm	mm	kg/km	kN	m
400RM	23.6 <sup>+0.30</sup>	24.0	74.8	575	101.2	112	11550	20.0	2.8
500RM	26.4 <sup>+0.40</sup>	23.0	75.4	580	101.8	112	12520	25.0	2.8
630RM	30.3 <sup>+0.40</sup>	22.0	77.5	590	103.9	115	13940	31.5	2.9
800RM	34.7 <sup>+0.40</sup>	22.0	81.3	620	107.7	119	15900	40.0	3.0
1000RM	38.3 <sup>+0.40</sup>	21.0	82.9	630	109.3	120	17880	50.0	3.1
1200RMS	41.6 <sup>+0.80</sup>	21.0	87.8	665	115.6	127	20440	60.0	3.2
1400RMS	45.8 <sup>+0.80</sup>	21.0	92.0	690	119.8	131	22580	70.0	3.3
1600RMS	49.6 <sup>+1.2</sup>	21.0	95.8	715	123.6	136	25060	80.0	3.4
1800RMS	53.2 <sup>+1.0</sup>	21.0	99.4	735	127.0	139	27660	90.0	3.5
2000RMS	54.6 <sup>+1.0</sup>	21.0	100.8	745	128.4	141	29260	100.0	3.5
2500RMS	60.0 <sup>+1.0</sup>	21.5	108.2	800	137.6	150	35040	100.0	3.8
3000RMS	68.4 <sup>+1.0</sup>	21.5	116.6	1070	147.0	161	42700	100.0	4.0

# HV XLPE CABLE WITH CORRUGATED ALUMINIUM SHEATH

127/220 ÷ 230 (245) kV

Electrical data

D<sub>e</sub> – Cable diameter

Cables in flat formation, the distance between the cable axes = 2 × D<sub>e</sub>



Cables in trefoil formation, the distance between the cable axes = D<sub>e</sub>



Cross section of conductor	Resistance of conductor 90°C	Electrical field stress at the		Capacitance	Zero reactance	Inductance	
		conductor screen	insulation			Ω/km	Ω/km
mm <sup>2</sup>	Ω/km	kV/mm		μF/km	Ω/km	Ω/km	
400RM	0.0619	9.25	3.30	0.130	0.105	0.220	0.160
500RM	0.0492	9.20	3.60	0.145	0.099	0.210	0.155
630RM	0.0395	9.05	3.95	0.160	0.090	0.205	0.145
800RM	0.0325	8.75	4.05	0.175	0.084	0.200	0.140
1000RM	0.0275	8.80	4.35	0.190	0.080	0.195	0.135
1200RMS	0.0222	8.55	4.45	0.205	0.078	0.190	0.135
1400RMS	0.0198	8.35	4.55	0.220	0.073	0.185	0.130
1600RMS	0.0182	8.20	4.60	0.235	0.071	0.185	0.125
1800RMS	0.0169	8.10	4.65	0.245	0.068	0.180	0.125
2000RMS	0.0158	8.05	4.70	0.250	0.067	0.180	0.120
2500RMS	0.0140	7.70	4.65	0.265	0.065	0.180	0.120
3000RMS	0.0126	7.55	4.75	0.290	0.062	0.175	0.115



# HV XLPE CABLE WITH CORRUGATED ALUMINIUM SHEATH

127/220 ÷ 230 (245) kV

A2X(F)KLD2Y according to IEC 62067

## ALUMINIUM CONDUCTOR

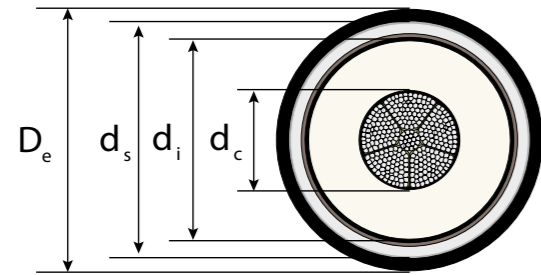

Cross section of conductor	Diameter of conductor	Insulation		Metallic screen		D <sub>e</sub> Outer diameter of cable	Cable weight	Maximum pulling force	Minimal bending radius
		Nominal thickness	Diameter over insulation	Cross section	Diameter over screen				
mm <sup>2</sup>	mm	mm	mm	mm <sup>2</sup>	mm	mm	kg/km	kN	m
400RM	22.9 <sup>+0.30</sup>	24.0	74.1	570	100.5	111	9020	14.0	2.8
500RM	25.7 <sup>+0.40</sup>	23.0	74.7	575	101.1	112	9340	17.5	2.8
630RM	29.3 <sup>+0.50</sup>	22.0	76.5	585	102.9	113	9840	22.1	2.9
800RM	33.0 <sup>+0.50</sup>	22.0	79.6	610	106.0	117	10650	28.0	2.9
1000RM	38.0 <sup>+0.50</sup>	21.0	82.6	625	109.0	120	11490	35.0	3.0
1200RM	42.5 <sup>+0.60</sup>	21.0	87.1	655	113.5	125	12660	42.0	3.1
1200RMS	43.0 <sup>+0.80</sup>	21.0	89.2	675	117.0	128	13100	42.0	3.2
1400RMS	45.1 <sup>+0.80</sup>	21.0	91.3	685	119.1	131	13920	49.0	3.3
1600RMS	48.5 <sup>+1.2</sup>	21.0	94.7	710	122.5	134	14920	56.0	3.4
1800RMS	52.7 <sup>+1.0</sup>	21.0	98.9	735	126.5	139	16140	63.0	3.5
2000RMS	54.5 <sup>+1.0</sup>	21.0	100.7	745	128.3	141	16820	70.0	3.5
2500RMS	59.0 <sup>+1.0</sup>	21.5	107.2	795	136.6	149	19110	87.5	3.7
3000RMS	67.0 <sup>+1.0</sup>	21.5	115.2	845	144.4	158	22110	100.0	4.0

# HV XLPE CABLE WITH CORRUGATED ALUMINIUM SHEATH

127/220 ÷ 230 (245) kV

## Electrical data

D<sub>e</sub> – Cable diameter

Cables in flat formation, the distance between the cable axes = 2 × D<sub>e</sub>



Cables in trefoil formation, the distance between the cable axes = D<sub>e</sub>



Cross section of conductor	Resistance of conductor 90°C	Electrical field stress at the		Capacitance	Zero reactance	Inductance	
		conductor	insulation screen				
mm <sup>2</sup>	Ω/km	kV/mm		μF/km	Ω/km	Ω/km	
400RM	0.1009	9.35	3.30	0.130	0.107	0.220	0.160
500RM	0.0792	9.30	3.55	0.140	0.100	0.215	0.155
630RM	0.0622	9.15	3.90	0.160	0.092	0.205	0.150
800RM	0.0498	8.90	4.00	0.170	0.087	0.200	0.140
1000RM	0.0408	8.85	4.35	0.190	0.079	0.195	0.135
1200RM	0.0359	8.60	4.45	0.205	0.076	0.190	0.130
1200RMS	0.0319	8.50	4.50	0.210	0.075	0.190	0.130
1400RMS	0.0275	8.40	4.55	0.220	0.074	0.190	0.130
1600RMS	0.0242	8.25	4.60	0.230	0.070	0.185	0.125
1800RMS	0.0216	8.10	4.65	0.245	0.068	0.180	0.125
2000RMS	0.0195	8.05	4.70	0.250	0.067	0.180	0.120
2500RMS	0.0168	7.75	4.65	0.260	0.066	0.180	0.120
3000RMS	0.0130	7.60	4.75	0.285	0.061	0.175	0.115

# HV XLPE CABLE WITH CORRUGATED ALUMINIUM SHEATH

220/380 ÷ 400 (420) kV

2X(F)KLD2Y according to IEC 62067

COPPER CONDUCTOR

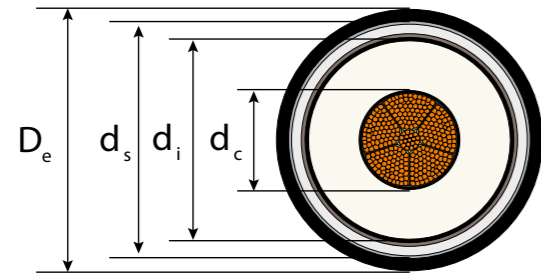

Cross section of conductor	Diameter of conductor	Insulation		Metallic screen		D <sub>e</sub> Outer diameter of cable	Cable weight	Maximum pulling force	Minimal bending radius
		Nominal thickness	Diameter over insulation	Cross section	Diameter over screen				
mm <sup>2</sup>	mm	mm	mm	mm <sup>2</sup>	mm	mm	kg/km	kN	m
630RM	30.3 <sup>+0.40</sup>	32.0	98.5	735	126.7	139	18150	31.5	3.5
800RM	34.7 <sup>+0.40</sup>	31.0	100.9	750	129.1	141	19930	40.0	3.5
1000RM	38.3 <sup>+0.40</sup>	30.0	102.5	765	131.9	144	22010	50.0	3.6
1200RMS	41.6 <sup>+0.80</sup>	28.0	101.8	755	130.2	143	23160	60.0	3.6
1400RMS	45.8 <sup>+0.80</sup>	27.0	104.0	775	133.4	146	25280	70.0	3.7
1600RMS	49.6 <sup>+1.2</sup>	27.0	107.8	795	137.2	150	27800	80.0	3.8
1800RMS	53.2 <sup>+1.0</sup>	27.0	111.4	820	140.8	154	30520	90.0	3.9
2000RMS	54.6 <sup>+1.0</sup>	27.0	112.8	830	142.2	155	32160	100.0	3.9
2500RMS	60.0 <sup>+1.0</sup>	27.0	119.2	1090	149.6	163	38410	100.0	4.1
3000RMS	68.4 <sup>+1.0</sup>	27.0	127.6	1155	158.0	172	45500	100.0	4.3

# HV XLPE CABLE WITH CORRUGATED ALUMINIUM SHEATH

220/380 ÷ 400 (420) kV

## Electrical data

D<sub>e</sub> – Cable diameter

Cables in flat formation, the distance between the cable axes = 2 × D<sub>e</sub>



Cables in trefoil formation, the distance between the cable axes = D<sub>e</sub>



Cross section of conductor	Resistance of conductor 90°C	Electrical field stress at the		Capacitance	Zero reactance	Inductance	
		conductor screen	insulation				
mm <sup>2</sup>	Ω/km	kV/mm		μF/km	Ω/km	Ω/km	
630RM	0.0395	12.20	4.30	0.130	0.104	0.215	0.160
800RM	0.0325	11.90	4.60	0.140	0.097	0.210	0.150
1000RM	0.0275	11.80	4.90	0.155	0.091	0.205	0.145
1200RMS	0.0222	12.05	5.45	0.170	0.086	0.200	0.140
1400RMS	0.0198	12.05	5.80	0.185	0.081	0.195	0.135
1600RMS	0.0182	11.80	5.90	0.195	0.077	0.190	0.130
1800RMS	0.0169	11.60	6.00	0.205	0.074	0.190	0.130
2000RMS	0.0158	11.50	6.00	0.210	0.073	0.185	0.130
2500RMS	0.0140	11.20	6.15	0.225	0.070	0.185	0.125
2500RMS	0.0126	10.90	6.30	0.245	0.067	0.180	0.120

# HV XLPE CABLE WITH CORRUGATED ALUMINIUM SHEATH

220/380 ÷ 400 (420) kV

A2X(F)KLD2Y according to IEC 62067

## ALUMINIUM CONDUCTOR

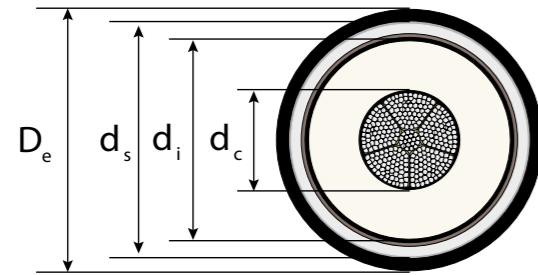

Cross section of conductor	Diameter of conductor	Insulation		Metallic screen		D <sub>e</sub> Outer diameter of cable	Cable weight	Maximum pulling force	Minimal bending radius
		Nominal thickness	Diameter over insulation	Cross section	Diameter over screen				
mm <sup>2</sup>	mm	mm	mm	mm <sup>2</sup>	mm	mm	kg/km	kN	m
630RM	29.3 <sup>+0.50</sup>	32.0	97.5	730	125.7	138	14000	22.1	3.4
800RM	33.0 <sup>+0.50</sup>	31.0	99.2	740	127.4	140	14660	28.0	3.5
1000RM	38.0 <sup>+0.50</sup>	30.0	102.2	760	131.6	144	15650	35.0	3.6
1200RM	42.5 <sup>+0.60</sup>	28.0	102.7	765	132.1	145	16120	42.0	3.6
1200RMS	43.0 <sup>+0.80</sup>	28.0	103.2	770	132.6	145	16180	42.0	3.6
1400RMS	45.1 <sup>+0.80</sup>	27.0	103.3	770	132.7	145	16600	49.0	3.6
1600RMS	48.5 <sup>+1.2</sup>	27.0	106.7	790	136.1	149	17670	56.0	3.7
1800RMS	52.7 <sup>+1.0</sup>	27.0	110.9	815	140.3	153	18940	63.0	3.8
2000RMS	54.5 <sup>+1.0</sup>	27.0	112.7	830	142.1	155	19710	70.0	3.9
2500RMS	59.0 <sup>+1.0</sup>	27.0	118.2	1080	148.6	162	22400	87.5	4.1
3000RMS	67.0 <sup>+1.0</sup>	27.0	126.2	1145	156.6	171	25600	100.0	4.3

# HV XLPE CABLE WITH CORRUGATED ALUMINIUM SHEATH

220/380 ÷ 400 (420) kV

## Electrical data

D<sub>e</sub> – Cable diameter

Cables in flat formation, the distance between the cable axes = 2 × D<sub>e</sub>



Cables in trefoil formation, the distance between the cable axes = D<sub>e</sub>



Cross section of conductor	Resistance of conductor 90°C	Electrical field stress at the		Capacitance	Zero reactance	Inductance	
		conductor screen	insulation				
mm <sup>2</sup>	Ω/km	kV/mm		μF/km	Ω/km	Ω/km	
630RM	0.0622	12.30	4.25	0.125	0.106	0.220	0.160
800RM	0.0498	12.10	4.55	0.140	0.099	0.210	0.155
1000RM	0.0408	11.80	4.90	0.155	0.093	0.205	0.145
1200RM	0.0359	12.00	5.45	0.170	0.086	0.200	0.140
1200RMS	0.0319	11.95	5.45	0.170	0.084	0.195	0.140
1400RMS	0.0275	12.10	5.80	0.180	0.082	0.195	0.135
1600RMS	0.0242	11.85	5.85	0.190	0.078	0.190	0.135
1800RMS	0.0216	11.60	5.95	0.200	0.075	0.190	0.130
2000RMS	0.0195	11.50	6.00	0.205	0.074	0.185	0.130
2500RMS	0.0168	11.25	6.10	0.220	0.072	0.185	0.125
3000RMS	0.0130	10.95	6.25	0.240	0.067	0.180	0.120

# HV XLPE CABLE WITH CORRUGATED ALUMINIUM SHEATH

290/500 (550) kV

2X(F)KLD2Y according to IEC 62067

COPPER CONDUCTOR

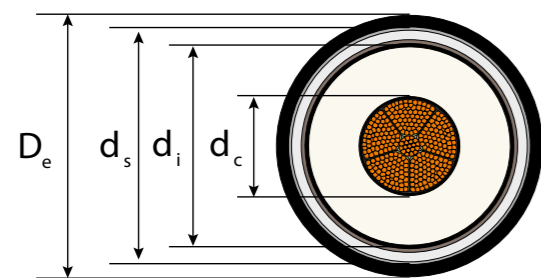

Cross section of conductor	Diameter of conductor	Insulation		Metallic screen		D <sub>e</sub> Outer diameter of cable	Cable weight	Maximum pulling force	Minimal bending radius
		Nominal thickness	Diameter over insulation	Cross section	Diameter over screen				
mm <sup>2</sup>	mm	mm	mm	mm <sup>2</sup>	mm	mm	kg/km	kN	m
1600RMS	49.6 <sup>+1.2</sup>	32.0	119.8	1105	151.2	165	31690	80.0	4.1
1800RMS	53.2 <sup>+1.0</sup>	31.0	121.4	1115	152.8	167	34000	90.0	4.2
2000RMS	54.6 <sup>+1.0</sup>	31.0	122.8	1125	154.2	168	35380	100.0	4.2
2500RMS	60.0 <sup>+1.0</sup>	30.0	126.2	1155	157.6	172	40470	100.0	4.3
3000RMS	68.4 <sup>+1.0</sup>	30.0	134.6	1220	166.0	181	47680	100.0	4.5

## Electrical data

D<sub>e</sub> – Cable diameter

Cables in flat formation, the distance between the cable axes = 2 × D<sub>e</sub>



Cables in trefoil formation, the distance between the cable axes = D<sub>e</sub>



# HV XLPE CABLE WITH CORRUGATED ALUMINIUM SHEATH

290/500 (550) kV

Cross section of conductor	Resistance of conductor 90°C	Electrical field stress at the		Capacitance	Zero reactance	Inductance	
		conductor screen	insulation			Ω/km	Ω/km
mm <sup>2</sup>	Ω/km	kV/mm		μF/km	Ω/km	Ω/km	
1600RMS	0.0182	13.65	6.35	0.175	0.084	0.195	0.140
1800RMS	0.0169	13.70	6.70	0.190	0.081	0.195	0.135
2000RMS	0.0158	13.60	6.75	0.190	0.079	0.190	0.135
2500RMS	0.0140	13.60	7.15	0.210	0.075	0.185	0.130
3000RMS	0.0126	13.20	7.35	0.230	0.070	0.180	0.125

# HV XLPE CABLE WITH CORRUGATED ALUMINIUM SHEATH

290/500 (550) kV

A2X(F)KLD2Y according to IEC 62067

## ALUMINIUM CONDUCTOR

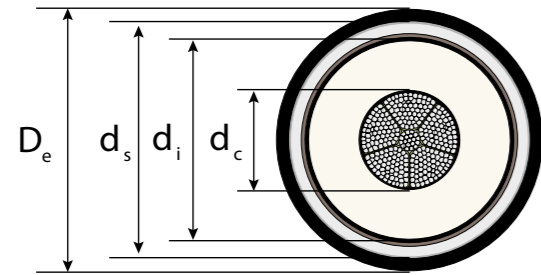

Cross section of conductor	Diameter of conductor	Insulation		Metallic screen		D <sub>e</sub> Outer diameter of cable	Cable weight	Maximum pulling force	Minimal bending radius
		Nominal thickness	Diameter over insulation	Cross section	Diameter over screen				
mm <sup>2</sup>	mm	mm	mm	mm <sup>2</sup>	mm	mm	kg/km	kN	m
1600RMS	48.5 <sup>+1.2</sup>	32.0	118.7	1095	150.1	164	21540	56.0	4.1
1800RMS	52.7 <sup>+1.0</sup>	31.0	120.9	1110	152.3	166	22460	63.0	4.2
2000RMS	54.5 <sup>+1.0</sup>	31.0	122.7	1125	154.1	168	23220	70.0	4.2
2500RMS	59.0 <sup>+1.0</sup>	30.0	125.2	1140	156.6	171	24500	87.5	4.3
3000RMS	67.0 <sup>+1.0</sup>	30.0	133.2	1210	164.6	179	27820	100.0	4.5

## Electrical data

D<sub>e</sub> – Cable diameter

Cables in flat formation, the distance between the cable axes = 2 × D<sub>e</sub>



Cables in trefoil formation, the distance between the cable axes = D<sub>e</sub>



# HV XLPE CABLE WITH CORRUGATED ALUMINIUM SHEATH

290/500 (550) kV

Cross section of conductor	Resistance of conductor 90°C	Electrical field stress at the		Capacitance	Zero reactance	Inductance	
		conductor screen	insulation			μF/km	Ω/km
mm <sup>2</sup>	Ω/km	kV/mm		μF/km	Ω/km	Ω/km	
1600RMS	0.0242	13.70	6.35	0.175	0.085	0.195	0.140
1800RMS	0.0216	13.70	6.70	0.185	0.080	0.195	0.135
2000RMS	0.0195	13.60	6.75	0.190	0.079	0.190	0.135
2500RMS	0.0168	13.65	7.15	0.205	0.075	0.190	0.130
3000RMS	0.0130	13.25	7.30	0.225	0.070	0.185	0.125

A large roll of dark green material, likely lead alloy sheath, is shown. The roll is partially unrolled, revealing the inner layers. A white text box is overlaid on the left side of the image. The background is a solid dark green color.

**HV XLPE cable with  
lead alloy sheath**

# HV XLPE CABLE WITH LEAD ALLOY SHEATH

26/45 ÷ 47 (52) kV

2X(F)K2Y according to IEC 60840

N2X(F)K2Y according to DIN VDE 0276-632

## COPPER CONDUCTOR

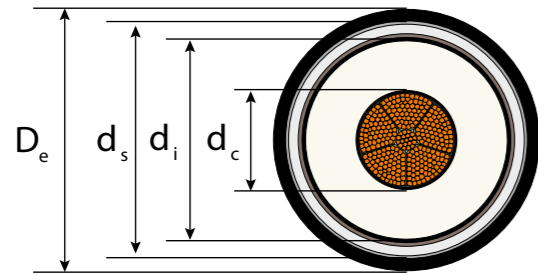

Cross section of conductor	Diameter of conductor	Insulation		Metallic screen		D <sub>e</sub> Outer diameter of cable	Cable weight	Maximum pulling force	Minimal bending radius
		Nominal thickness	Diameter over insulation	Cross section	Diameter over screen				
mm <sup>2</sup>	mm	mm	mm	mm <sup>2</sup>	mm	mm	kg/km	kN	m
500RM	26.4 <sup>+0.40</sup>	9.0	46.0	315	52.5	59	9790	25.0	1.2
630RM	30.3 <sup>+0.40</sup>	9.0	50.1	340	56.6	63	11500	31.5	1.3
800RM	34.7 <sup>+0.40</sup>	9.0	54.5	370	61.0	68	13560	40.0	1.4
1000RM	38.3 <sup>+0.40</sup>	9.0	58.5	395	65.4	73	16010	50.0	1.5
1200RMS	41.6 <sup>+0.80</sup>	9.0	63.8	430	70.7	79	18580	60.0	1.6
1400RMS	45.8 <sup>+0.80</sup>	9.0	68.0	455	74.9	83	20730	70.0	1.7
1600RMS	49.6 <sup>+1.2</sup>	9.0	71.8	480	78.7	87	23200	80.0	1.7
1800RMS	53.2 <sup>+1.0</sup>	9.0	75.4	500	82.3	91	25800	90.0	1.8
2000RMS	54.6 <sup>+1.0</sup>	9.0	76.8	510	83.7	92	27420	100.0	1.9
2500RMS	60.0 <sup>+1.0</sup>	9.0	83.2	555	90.5	100	32870	100.0	2.0
3000RMS	68.4 <sup>+1.0</sup>	9.0	91.6	605	98.9	109	39730	100.0	2.2

# HV XLPE CABLE WITH LEAD ALLOY SHEATH

26/45 ÷ 47 (52) kV

## Electrical data

D<sub>e</sub> – Cable diameter

Cables in flat formation, the distance between the cable axes = 2 × D<sub>e</sub>



Cables in trefoil formation, the distance between the cable axes = D<sub>e</sub>



Cross section of conductor	Resistance of conductor 90°C	Electrical field stress at the		Capacitance	Zero reactance	Inductance	
		conductor	insulation			Ω/km	Ω/km
mm <sup>2</sup>	Ω/km	kV/mm		μF/km	Ω/km	Ω/km	
500RM	0.0492	3.75	2.30	0.270	0.060	0.170	0.115
630RM	0.0395	3.65	2.35	0.300	0.057	0.165	0.110
800RM	0.0325	3.60	2.40	0.335	0.053	0.165	0.105
1000RM	0.0275	3.50	2.45	0.365	0.051	0.160	0.105
1200RMS	0.0222	3.45	2.50	0.405	0.051	0.160	0.105
1400RMS	0.0198	3.40	2.50	0.435	0.048	0.160	0.100
1600RMS	0.0182	3.35	2.55	0.465	0.046	0.155	0.100
1800RMS	0.0169	3.35	2.55	0.490	0.045	0.155	0.095
2000RMS	0.0158	3.35	2.55	0.500	0.044	0.155	0.095
2500RMS	0.0140	3.30	2.60	0.550	0.043	0.155	0.095
3000RMS	0.0126	3.25	2.60	0.610	0.040	0.150	0.090

# HV XLPE CABLE WITH LEAD ALLOY SHEATH

26/45 ÷ 47 (52) kV

A2X(F)K2Y according to IEC 60840

NA2X(F)K2Y according to DIN VDE 0276-632

## ALUMINIUM CONDUCTOR

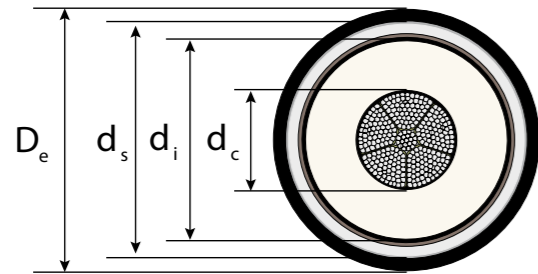

Cross section of conductor	Diameter of conductor	Insulation		Metallic screen		D <sub>e</sub> Outer diameter of cable	Cable weight	Maximum pulling force	Minimal bending radius
		Nominal thickness	Diameter over insulation	Cross section	Diameter over screen				
mm <sup>2</sup>	mm	mm	mm	mm <sup>2</sup>	mm	mm	kg/km	kN	m
500RM	25.7 <sup>+0.40</sup>	9.0	45.3	310	51.8	58	6590	17.5	1.2
630RM	29.3 <sup>+0.50</sup>	9.0	49.1	335	55.6	62	7440	22.1	1.3
800RM	33.0 <sup>+0.50</sup>	9.0	52.8	360	59.3	66	8330	28.0	1.3
1000RM	38.0 <sup>+0.50</sup>	9.0	58.2	395	65.1	73	9660	35.0	1.5
1200RM	42.5 <sup>+0.60</sup>	9.0	62.7	420	69.6	77	10810	42.0	1.6
1200RMS	43.0 <sup>+0.80</sup>	9.0	65.2	440	72.1	80	11250	42.0	1.6
1400RMS	45.1 <sup>+0.80</sup>	9.0	67.3	450	74.2	82	12070	49.0	1.6
1600RMS	48.5 <sup>+1.2</sup>	9.0	70.7	475	77.6	86	13060	56.0	1.7
1800RMS	52.7 <sup>+1.0</sup>	9.0	74.9	500	81.8	90	14280	63.0	1.8
2000RMS	54.5 <sup>+1.0</sup>	9.0	76.7	510	83.6	92	14970	70.0	1.8
2500RMS	59.0 <sup>+1.0</sup>	9.0	82.2	550	89.5	99	16900	87.5	2.0
3000RMS	67.0 <sup>+1.0</sup>	9.0	90.2	600	97.5	107	19880	100.0	2.1

# HV XLPE CABLE WITH LEAD ALLOY SHEATH

26/45 ÷ 47 (52) kV

## Electrical data

D<sub>e</sub> – Cable diameter

Cables in flat formation, the distance between the cable axes = 2 × D<sub>e</sub>



Cables in trefoil formation, the distance between the cable axes = D<sub>e</sub>



Cross section of conductor	Resistance of conductor 90°C	Electrical field stress at the		Capacitance	Zero reactance	Inductance	
		conductor	insulation screen				
mm <sup>2</sup>	Ω/km	kV/mm		μF/km	Ω/km	Ω/km	
500RM	0.0792	3.80	2.30	0.265	0.061	0.170	0.115
630RM	0.0622	3.70	2.35	0.295	0.057	0.170	0.110
800RM	0.0498	3.60	2.40	0.320	0.054	0.165	0.105
1000RM	0.0408	3.50	2.45	0.360	0.051	0.160	0.105
1200RM	0.0359	3.45	2.45	0.395	0.048	0.160	0.100
1200RMS	0.0319	3.45	2.50	0.415	0.050	0.160	0.100
1400RMS	0.0275	3.40	2.50	0.430	0.049	0.160	0.100
1600RMS	0.0242	3.40	2.55	0.445	0.047	0.155	0.100
1800RMS	0.0216	3.35	2.55	0.485	0.045	0.155	0.095
2000RMS	0.0195	3.35	2.55	0.500	0.044	0.155	0.095
2500RMS	0.0168	3.30	2.60	0.540	0.043	0.155	0.095
3000RMS	0.0130	3.25	2.60	0.600	0.041	0.160	0.090



# HV XLPE CABLE WITH LEAD ALLOY SHEATH

36/60 ÷ 69 (72.5) kV

2X(F)K2Y according to IEC 60840

N2X(F)K2Y according to DIN VDE 0276-632

## COPPER CONDUCTOR

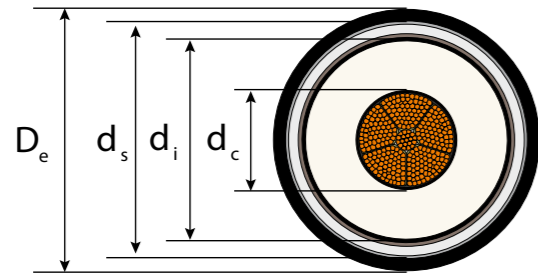

Cross section of conductor	Diameter of conductor	Insulation		Metallic screen		D <sub>e</sub> Outer diameter of cable	Cable weight	Maximum pulling force	Minimal bending radius
		Nominal thickness	Diameter over insulation	Cross section	Diameter over screen				
mm <sup>2</sup>	mm	mm	mm	mm <sup>2</sup>	mm	mm	kg/km	kN	m
400RM	23.6 <sup>+0.30</sup>	10.0	45.2	310	51.7	58	8780	20.0	1.2
500RM	26.4 <sup>+0.40</sup>	10.0	48.0	330	54.5	61	10100	25.0	1.2
630RM	30.3 <sup>+0.40</sup>	10.0	52.1	355	58.6	66	11840	31.5	1.3
800RM	34.7 <sup>+0.40</sup>	10.0	56.5	380	63.0	70	13900	40.0	1.4
1000RM	38.3 <sup>+0.40</sup>	10.0	60.5	410	67.4	75	16380	50.0	1.5
1200RMS	41.6 <sup>+0.80</sup>	10.0	65.8	440	72.7	81	18970	60.0	1.6
1400RMS	45.8 <sup>+0.80</sup>	10.0	70.0	470	76.9	85	21130	70.0	1.7
1600RMS	49.6 <sup>+1.2</sup>	10.0	73.8	490	80.7	89	23580	80.0	1.8
1800RMS	53.2 <sup>+1.0</sup>	10.0	77.4	515	84.3	93	26220	90.0	1.9
2000RMS	54.6 <sup>+1.0</sup>	10.0	78.8	525	85.7	95	27850	100.0	1.9
2500RMS	60.0 <sup>+1.0</sup>	10.0	85.2	565	92.5	102	33320	100.0	2.0
3000RMS	68.4 <sup>+1.0</sup>	10.0	93.6	620	100.9	111	40180	100.0	2.2

# HV XLPE CABLE WITH LEAD ALLOY SHEATH

36/60 ÷ 69 (72.5) kV

## Electrical data

D<sub>e</sub> – Cable diameter

Cables in flat formation, the distance between the cable axes = 2 × D<sub>e</sub>



Cables in trefoil formation, the distance between the cable axes = D<sub>e</sub>



Cross section of conductor	Resistance of conductor 90°C	Electrical field stress at the		Capacitance	Zero reactance	Inductance	
		conductor	insulation				
mm <sup>2</sup>	Ω/km	kV/mm		μF/km	Ω/km	Ω/km	
400RM	0.0619	4.90	2.75	0.230	0.067	0.175	0.120
500RM	0.0492	4.80	2.80	0.250	0.063	0.175	0.105
630RM	0.0395	4.65	2.90	0.275	0.059	0.170	0.110
800RM	0.0325	4.55	2.95	0.305	0.055	0.165	0.105
1000RM	0.0275	4.45	3.00	0.335	0.053	0.165	0.105
1200RMS	0.0222	4.35	3.05	0.370	0.052	0.160	0.105
1400RMS	0.0198	4.30	3.10	0.400	0.050	0.160	0.100
1600RMS	0.0182	4.25	3.10	0.425	0.048	0.160	0.100
1800RMS	0.0169	4.20	3.15	0.450	0.047	0.155	0.100
2000RMS	0.0158	4.20	3.15	0.455	0.044	0.155	0.095
2500RMS	0.0140	4.15	3.20	0.500	0.044	0.155	0.095
3000RMS	0.0126	4.10	3.25	0.555	0.042	0.150	0.090

# HV XLPE CABLE WITH LEAD ALLOY SHEATH

36/60 ÷ 69 (72.5) kV

A2X(F)K2Y according to IEC 60840

NA2X(F)K2Y according to DIN VDE 0276-632

## ALUMINIUM CONDUCTOR

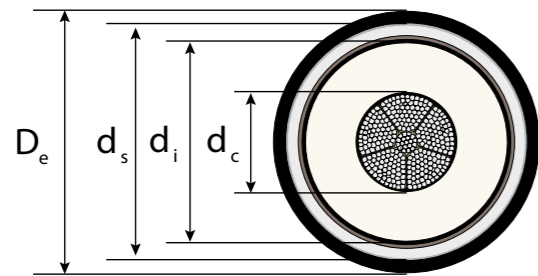

Cross section of conductor	Diameter of conductor	Insulation		Metallic screen		D <sub>e</sub> Outer diameter of cable	Cable weight	Maximum pulling force	Minimal bending radius
		Nominal thickness	Diameter over insulation	Cross section	Diameter over screen				
mm <sup>2</sup>	mm	mm	mm	mm <sup>2</sup>	mm	mm	kg/km	kN	m
400RM	22.9 <sup>+0.30</sup>	10.0	44.5	305	51.0	57	6280	14.0	1.2
500RM	25.7 <sup>+0.40</sup>	10.0	47.3	325	53.8	60	6920	17.5	1.2
630RM	29.3 <sup>+0.50</sup>	10.0	51.1	345	57.6	64	7760	22.1	1.3
800RM	33.0 <sup>+0.50</sup>	10.0	54.8	370	61.3	69	8680	28.0	1.4
1000RM	38.0 <sup>+0.50</sup>	10.0	60.2	405	67.1	75	10020	35.0	1.5
1200RM	42.5 <sup>+0.60</sup>	10.0	64.7	435	71.6	79	11170	42.0	1.6
1200RMS	43.0 <sup>+0.80</sup>	10.0	67.2	450	74.1	82	11640	42.0	1.6
1400RMS	45.1 <sup>+0.80</sup>	10.0	69.3	465	76.2	84	12470	49.0	1.7
1600RMS	48.5 <sup>+1.2</sup>	10.0	72.7	485	79.6	88	13470	56.0	1.8
1800RMS	52.7 <sup>+1.0</sup>	10.0	76.9	510	83.8	92	14670	63.0	1.9
2000RMS	54.5 <sup>+1.0</sup>	10.0	78.7	525	85.6	94	15400	70.0	1.9
2500RMS	59.0 <sup>+1.0</sup>	10.0	84.2	560	91.5	101	17350	87.5	2.0
3000RMS	67.0 <sup>+1.0</sup>	10.0	92.2	610	99.5	109	20360	100.0	2.2

# HV XLPE CABLE WITH LEAD ALLOY SHEATH

36/60 ÷ 69 (72.5) kV

## Electrical data

D<sub>e</sub> – Cable diameter

Cables in flat formation, the distance between the cable axes = 2 × D<sub>e</sub>



Cables in trefoil formation, the distance between the cable axes = D<sub>e</sub>



Cross section of conductor	Resistance of conductor 90°C	Electrical field stress at the		Capacitance	Zero reactance	Inductance	
		conductor	insulation				
mm <sup>2</sup>	Ω/km	kV/mm		μF/km	Ω/km	Ω/km	
400RM	0.1009	4.95	2.75	0.225	0.068	0.180	0.120
500RM	0.0792	4.80	2.80	0.245	0.064	0.175	0.115
630RM	0.0622	4.70	2.85	0.270	0.060	0.170	0.110
800RM	0.0498	4.60	2.90	0.295	0.056	0.165	0.110
1000RM	0.0408	4.45	3.00	0.330	0.053	0.165	0.105
1200RM	0.0359	4.40	3.05	0.365	0.050	0.160	0.100
1200RMS	0.0319	4.35	3.05	0.380	0.051	0.160	0.100
1400RMS	0.0275	4.30	3.10	0.395	0.050	0.160	0.100
1600RMS	0.0242	4.25	3.10	0.415	0.048	0.160	0.100
1800RMS	0.0216	4.25	3.15	0.445	0.046	0.155	0.100
2000RMS	0.0195	4.20	3.15	0.455	0.046	0.155	0.095
2500RMS	0.0168	4.15	3.20	0.495	0.045	0.155	0.095
3000RMS	0.0130	4.10	3.20	0.545	0.042	0.150	0.095

# HV XLPE CABLE WITH LEAD ALLOY SHEATH

64/110 ÷ 115 (123) kV

2X(F)K2Y according to IEC 60840

N2X(F)K2Y according to DIN VDE 0276-632

COPPER CONDUCTOR

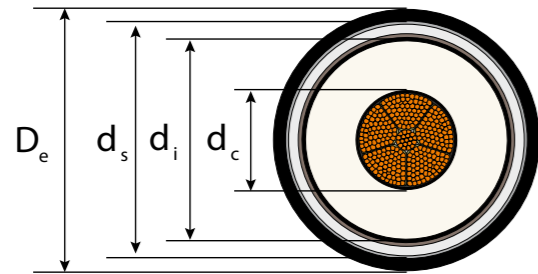

Cross section of conductor	Diameter of conductor	Insulation		Metallic screen		D <sub>e</sub> Outer diameter of cable	Cable weight	Maximum pulling force	Minimal bending radius
		Nominal thickness	Diameter over insulation	Cross section	Diameter over screen				
mm <sup>2</sup>	mm	mm	mm	mm <sup>2</sup>	mm	mm	kg/km	kN	m
150RM	14.4 <sup>+0.20</sup>	18.0	53.4	360	60.3	67	8300	7.5	1.4
185RM	15.8 <sup>+0.40</sup>	17.0	52.2	355	59.1	66	8400	9.3	1.3
240RM	18.5 <sup>+0.30</sup>	16.5	53.5	365	60.4	67	9030	12.0	1.4
300RM	20.5 <sup>+0.20</sup>	15.5	53.5	365	60.4	67	9540	15.0	1.4
400RM	23.6 <sup>+0.30</sup>	14.5	54.6	370	61.5	69	10410	20.0	1.4
500RM	26.4 <sup>+0.40</sup>	14.0	56.4	385	63.3	71	11590	25.0	1.4
630RM	30.3 <sup>+0.40</sup>	14.0	60.9	410	67.8	75	13470	31.5	1.5
800RM	34.7 <sup>+0.40</sup>	14.0	65.3	440	72.2	80	15590	40.0	1.6
1000RM	38.3 <sup>+0.40</sup>	14.0	68.9	460	75.8	84	17980	50.0	1.7
1200RMS	41.6 <sup>+0.80</sup>	14.0	73.8	490	80.7	89	20530	60.0	1.8
1400RMS	45.8 <sup>+0.80</sup>	14.0	78.0	520	84.9	94	22780	70.0	1.9
1600RMS	49.6 <sup>+1.2</sup>	14.0	81.8	545	88.7	98	25280	80.0	2.0
1800RMS	53.2 <sup>+1.0</sup>	14.0	85.4	565	92.3	102	27940	90.0	2.0
2000RMS	54.6 <sup>+1.0</sup>	14.0	86.8	575	93.7	103	29610	100.0	2.1
2500RMS	60.0 <sup>+1.0</sup>	14.5	94.2	620	101.5	112	35400	100.0	2.2
3000RMS	68.4 <sup>+1.0</sup>	14.5	102.6	675	109.9	121	42420	100.0	2.4

# HV XLPE CABLE WITH LEAD ALLOY SHEATH

64/110 ÷ 115 (123) kV

## Electrical data

D<sub>e</sub> – Cable diameter

Cables in flat formation, the distance between the cable axes = 2 × D<sub>e</sub>



Cables in trefoil formation, the distance between the cable axes = D<sub>e</sub>



Cross section of conductor	Resistance of conductor 90°C	Electrical field stress at the		Capacitance	Zero reactance	Inductance	
		conductor	insulation			conductor	insulation
mm <sup>2</sup>	Ω/km	kV/mm		μF/km	Ω/km	Ω/km	
150RM	0.1588	6.56	2.14	0.119	0.105	0.215	0.160
185RM	0.1272	6.67	2.33	0.127	0.099	0.210	0.150
240RM	0.0973	6.51	2.49	0.135	0.091	0.200	0.145
300RM	0.0781	6.57	2.76	0.154	0.084	0.195	0.135
400RM	0.0619	6.60	3.10	0.176	0.076	0.185	0.130
500RM	0.0492	6.60	3.35	0.195	0.072	0.185	0.125
630RM	0.0395	6.35	3.45	0.220	0.068	0.180	0.120
800RM	0.0325	6.15	3.50	0.240	0.063	0.175	0.115
1000RM	0.0275	6.05	3.60	0.260	0.060	0.170	0.115
1200RMS	0.0222	5.90	3.65	0.280	0.059	0.170	0.110
1400RMS	0.0198	5.80	3.70	0.300	0.056	0.165	0.110
1600RMS	0.0182	5.70	3.75	0.320	0.054	0.165	0.105
1800RMS	0.0169	5.65	3.80	0.340	0.052	0.160	0.105
2000RMS	0.0158	5.60	3.80	0.345	0.051	0.160	0.105
2500RMS	0.0140	5.35	3.70	0.365	0.050	0.160	0.100
3000RMS	0.0126	5.30	3.80	0.405	0.047	0.155	0.100

# HV XLPE CABLE WITH LEAD ALLOY SHEATH

64/110 ÷ 115 (123) kV

A2X(F)K2Y according to IEC 60840

NA2X(F)K2Y according to DIN VDE 0276-632

## ALUMINIUM CONDUCTOR

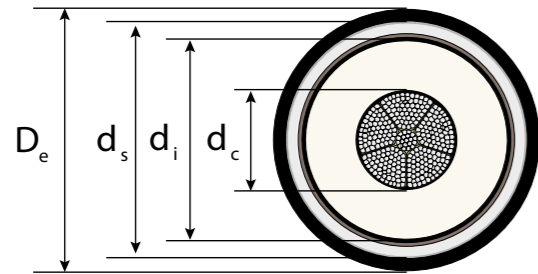

Cross section of conductor	Diameter of conductor	Insulation		Metallic screen		D <sub>e</sub> Outer diameter of cable	Cable weight	Maximum pulling force	Minimal bending radius
		Nominal thickness	Diameter over insulation	Cross section	Diameter over screen				
mm <sup>2</sup>	mm	mm	mm	mm <sup>2</sup>	mm	mm	kg/km	kN	m
150RM	14.1 <sup>+0.30</sup>	18.0	53.1	360	60.0	67	7360	5.3	1.3
185RM	15.8 <sup>+0.20</sup>	17.0	52.2	355	59.1	66	7270	6.5	1.3
240RM	17.9 <sup>+0.10</sup>	16.5	52.9	360	59.8	67	7480	8.4	1.3
300RM	20.0 <sup>+0.30</sup>	15.5	53.0	360	59.9	67	7600	10.5	1.3
400RM	22.9 <sup>+0.30</sup>	14.5	53.9	365	60.8	68	7890	14.0	1.4
500RM	25.7 <sup>+0.40</sup>	14.0	55.7	380	62.6	70	8400	17.5	1.4
630RM	29.3 <sup>+0.50</sup>	14.0	59.9	405	66.8	74	9390	22.1	1.5
800RM	33.0 <sup>+0.50</sup>	14.0	63.6	430	70.5	78	10350	28.0	1.6
1000RM	38.0 <sup>+0.50</sup>	14.0	68.6	460	75.5	84	11620	35.0	1.7
1200RM	42.5 <sup>+0.60</sup>	14.0	73.1	490	80.0	88	12830	42.0	1.8
1200RMS	43.0 <sup>+0.80</sup>	14.0	75.2	500	82.1	91	13250	42.0	1.8
1400RMS	45.1 <sup>+0.80</sup>	14.0	77.3	515	84.2	93	14100	49.0	1.9
1600RMS	48.5 <sup>+1.2</sup>	14.0	80.7	535	87.6	97	15160	56.0	1.9
1800RMS	52.7 <sup>+1.0</sup>	14.0	84.9	560	91.8	101	16410	63.0	2.0
2000RMS	54.5 <sup>+1.0</sup>	14.0	86.7	575	93.6	103	17160	70.0	2.1
2500RMS	59.0 <sup>+1.0</sup>	14.5	93.2	615	100.5	110	19420	87.5	2.2
3000RMS	67.0 <sup>+1.0</sup>	14.5	101.2	665	108.5	119	22550	100.0	2.4

# HV XLPE CABLE WITH LEAD ALLOY SHEATH

64/110 ÷ 115 (123) kV

## Electrical data

D<sub>e</sub> – Cable diameter

Cables in flat formation, the distance between the cable axes = 2 × D<sub>e</sub>



Cables in trefoil formation, the distance between the cable axes = D<sub>e</sub>



Cross section of conductor	Resistance of conductor 90°C	Electrical field stress at the		Capacitance	Zero reactance	Inductance	
		conductor screen	insulation			Ω/km	Ω/km
mm <sup>2</sup>	Ω/km	kV/mm		μF/km	Ω/km	Ω/km	
150RM	0.2645	6.61	2.13	0.118	0.106	0.215	0.160
185RM	0.2108	6.67	2.23	0.127	0.100	0.210	0.150
240RM	0.1610	6.58	2.47	0.130	0.092	0.205	0.145
300RM	0.1291	6.62	2.75	0.152	0.085	0.195	0.140
400RM	0.1009	6.66	3.08	0.172	0.078	0.190	0.130
500RM	0.0792	6.65	3.30	0.195	0.073	0.185	0.125
630RM	0.0622	6.40	3.40	0.215	0.069	0.180	0.120
800RM	0.0498	6.20	3.50	0.230	0.065	0.175	0.115
1000RM	0.0408	6.05	3.60	0.255	0.060	0.170	0.110
1200RM	0.0359	5.90	3.65	0.280	0.057	0.165	0.110
1200RMS	0.0319	5.85	3.70	0.290	0.058	0.165	0.110
1400RMS	0.0275	5.80	3.70	0.300	0.056	0.165	0.110
1600RMS	0.0242	5.70	3.75	0.315	0.054	0.165	0.105
1800RMS	0.0216	5.65	3.80	0.335	0.052	0.160	0.105
2000RMS	0.0195	5.60	3.80	0.345	0.051	0.160	0.105
2500RMS	0.0168	5.35	3.70	0.360	0.051	0.160	0.100
3000RMS	0.0140	5.25	3.75	0.400	0.048	0.155	0.100

# HV XLPE CABLE WITH LEAD ALLOY SHEATH

76/132 ÷ 138 (145) kV

2X(F)K2Y according to IEC 60840

N2X(F)K2Y according to DIN VDE 0276-632

## COPPER CONDUCTOR

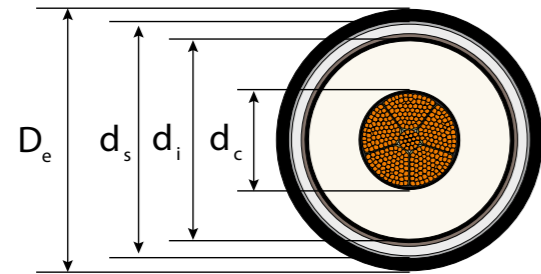

Cross section of conductor	Diameter of conductor	Insulation		Metallic screen		D <sub>e</sub> Outer diameter of cable	Cable weight	Maximum pulling force	Minimal bending radius
		Nominal thickness	Diameter over insulation	Cross section	Diameter over screen				
mm <sup>2</sup>	mm	mm	mm	mm <sup>2</sup>	mm	mm	kg/km	kN	m
185RM	15.8 <sup>+0.40</sup>	18.0	54.8	375	61.7	69	8850	9.3	1.3
240RM	18.5 <sup>+0.30</sup>	17.0	55.5	375	62.4	70	9390	12.0	1.4
300RM	20.5 <sup>+0.20</sup>	16.5	55.9	380	62.8	70	9970	15.0	1.4
400RM	23.6 <sup>+0.30</sup>	16.0	57.6	390	64.5	72	10940	20.0	1.4
500RM	26.4 <sup>+0.40</sup>	16.0	60.4	410	67.3	75	12320	25.0	1.5
630RM	30.3 <sup>+0.40</sup>	16.0	64.9	435	71.8	80	14210	31.5	1.6
800RM	34.7 <sup>+0.40</sup>	16.0	69.3	465	76.2	84	16380	40.0	1.7
1000RM	38.3 <sup>+0.40</sup>	16.0	72.9	485	79.8	88	18770	50.0	1.8
1200RMS	41.6 <sup>+0.80</sup>	16.0	77.8	515	84.7	94	21380	60.0	1.9
1400RMS	45.8 <sup>+0.80</sup>	16.0	82.0	545	88.9	98	23630	70.0	2.0
1600RMS	49.6 <sup>+1.2</sup>	16.0	85.8	570	92.7	102	26190	80.0	2.0
1800RMS	53.2 <sup>+1.0</sup>	16.0	89.4	590	96.3	106	28870	90.0	2.1
2000RMS	54.6 <sup>+1.0</sup>	16.0	90.8	600	97.7	107	30520	100.0	2.2
2500RMS	60.0 <sup>+1.0</sup>	16.0	97.2	640	104.5	115	36130	100.0	2.3
3000RMS	68.4 <sup>+1.0</sup>	16.0	105.6	695	112.9	124	43190	100.0	2.5

# HV XLPE CABLE WITH LEAD ALLOY SHEATH

76/132 ÷ 138 (145) kV

## Electrical data

D<sub>e</sub> – Cable diameter

Cables in flat formation, the distance between the cable axes = 2 × D<sub>e</sub>



Cables in trefoil formation, the distance between the cable axes = D<sub>e</sub>



Cross section of conductor	Resistance of conductor 90°C	Electrical field stress at the		Capacitance	Zero reactance	Inductance	
		conductor	insulation			Flat formation	Trefoil formation
mm <sup>2</sup>	Ω/km	kV/mm		μF/km	Ω/km	Ω/km	
185RM	0.1272	7.60	2.60	0.125	0.103	0.215	0.155
240RM	0.0973	7.50	2.90	0.145	0.094	0.205	0.145
300RM	0.0781	7.45	3.05	0.150	0.088	0.200	0.140
400RM	0.0619	7.35	3.30	0.165	0.080	0.190	0.135
500RM	0.0492	7.10	3.35	0.180	0.076	0.185	0.130
630RM	0.0395	6.80	3.45	0.200	0.071	0.180	0.125
800RM	0.0325	6.60	3.55	0.215	0.067	0.175	0.120
1000RM	0.0275	6.45	3.65	0.235	0.063	0.175	0.115
1200RMS	0.0222	6.30	3.70	0.255	0.062	0.170	0.115
1400RMS	0.0198	6.15	3.75	0.270	0.059	0.170	0.110
1600RMS	0.0182	6.10	3.80	0.290	0.057	0.165	0.110
1800RMS	0.0169	6.00	3.85	0.305	0.055	0.165	0.105
2000RMS	0.0158	5.95	3.90	0.310	0.054	0.165	0.105
2500RMS	0.0140	5.85	3.95	0.335	0.052	0.160	0.105
3000RMS	0.0126	5.75	3.95	0.370	0.049	0.160	0.100

# HV XLPE CABLE WITH LEAD ALLOY SHEATH

76/132 ÷ 138 (145) kV

A2X(F)K2Y according to IEC 60840

NA2X(F)K2Y according to DIN VDE 0276-632

## ALUMINIUM CONDUCTOR

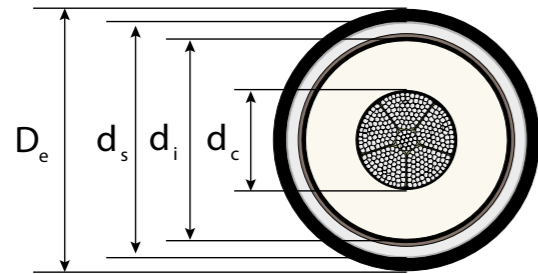

Cross section of conductor	Diameter of conductor	Insulation		Metallic screen		D <sub>e</sub> Outer diameter of cable	Cable weight	Maximum pulling force	Minimal bending radius
		Nominal thickness	Diameter over insulation	Cross section	Diameter over screen				
mm <sup>2</sup>	mm	mm	mm	mm <sup>2</sup>	mm	mm	kg/km	kN	m
185RM	15.8 <sup>+0.20</sup>	18.0	54.8	375	61.7	69	7720	6.5	1.4
240RM	17.9 <sup>+0.10</sup>	17.0	54.9	375	61.8	69	7840	8.4	1.4
300RM	20.0 <sup>+0.30</sup>	16.5	55.4	375	62.3	70	8020	10.5	1.4
400RM	22.9 <sup>+0.30</sup>	16.0	56.9	385	63.8	71	8410	14.0	1.4
500RM	25.7 <sup>+0.40</sup>	16.0	59.7	405	66.6	74	9100	17.5	1.5
630RM	29.3 <sup>+0.50</sup>	16.0	63.9	430	70.8	79	10120	22.1	1.6
800RM	33.0 <sup>+0.50</sup>	16.0	67.6	455	74.5	83	11100	28.0	1.7
1000RM	38.0 <sup>+0.50</sup>	16.0	72.6	485	79.5	88	12410	35.0	1.8
1200RM	42.5 <sup>+0.60</sup>	16.0	77.1	515	84.0	93	13680	42.0	1.9
1200RMS	43.0 <sup>+0.80</sup>	16.0	79.2	525	86.1	95	14080	42.0	1.9
1400RMS	45.1 <sup>+0.80</sup>	16.0	81.3	540	88.2	97	14950	49.0	1.9
1600RMS	48.5 <sup>+1.2</sup>	16.0	84.7	560	91.6	101	16020	56.0	2.0
1800RMS	52.7 <sup>+1.0</sup>	16.0	88.9	585	95.8	105	17340	63.0	2.1
2000RMS	54.5 <sup>+1.0</sup>	16.0	90.7	600	97.6	107	18070	70.0	2.1
2500RMS	59.0 <sup>+1.0</sup>	16.0	96.2	635	103.5	114	20140	87.5	2.3
3000RMS	67.0 <sup>+1.0</sup>	16.0	104.2	685	111.5	122	23310	100.0	2.4

# HV XLPE CABLE WITH LEAD ALLOY SHEATH

76/132 ÷ 138 (145) kV

## Electrical data

D<sub>e</sub> – Cable diameter

Cables in flat formation, the distance between the cable axes = 2 × D<sub>e</sub>



Cables in trefoil formation, the distance between the cable axes = D<sub>e</sub>



Cross section of conductor	Resistance of conductor 90°C	Electrical field stress at the		Capacitance	Zero reactance	Inductance	
		conductor screen	insulation			Ω/km	Ω/km
mm <sup>2</sup>	Ω/km	kV/mm		μF/km	Ω/km	Ω/km	
185RM	0.2108	7.60	2.60	0.125	0.103	0.215	0.155
240RM	0.1610	7.55	2.90	0.140	0.095	0.205	0.150
300RM	0.1291	7.50	3.05	0.150	0.089	0.200	0.140
400RM	0.1009	7.40	3.25	0.165	0.082	0.190	0.135
500RM	0.0792	7.15	3.35	0.175	0.077	0.185	0.130
630RM	0.0622	6.90	3.45	0.195	0.073	0.185	0.125
800RM	0.0498	6.70	3.55	0.210	0.068	0.180	0.120
1000RM	0.0408	6.45	3.65	0.230	0.064	0.175	0.115
1200RM	0.0359	6.30	3.70	0.250	0.060	0.170	0.115
1200RMS	0.0319	6.25	3.75	0.260	0.061	0.170	0.115
1400RMS	0.0275	6.20	3.75	0.270	0.059	0.170	0.110
1600RMS	0.0242	6.10	3.80	0.285	0.057	0.165	0.110
1800RMS	0.0216	6.00	3.85	0.300	0.055	0.165	0.105
2000RMS	0.0195	6.00	3.90	0.310	0.054	0.165	0.105
2500RMS	0.0168	5.90	3.95	0.330	0.053	0.160	0.105
3000RMS	0.0130	5.75	3.95	0.365	0.049	0.160	0.100

# HV XLPE CABLE WITH LEAD ALLOY SHEATH

87/150 ÷ 161 (170) kV

2X(F)K2Y according to IEC 60840

N2X(F)K2Y according to DIN VDE 0276-632

## COPPER CONDUCTOR

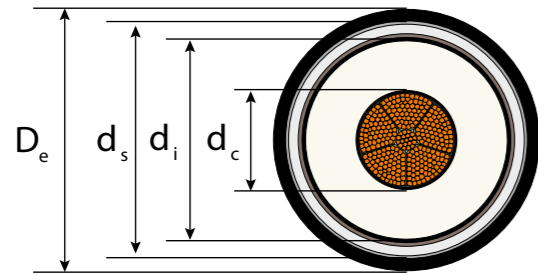

Cross section of conductor	Diameter of conductor	Insulation		Metallic screen		D <sub>e</sub> Outer diameter of cable	Cable weight	Maximum pulling force	Minimal bending radius
		Nominal thickness	Diameter over insulation	Cross section	Diameter over screen				
mm <sup>2</sup>	mm	mm	mm	mm <sup>2</sup>	mm	mm	kg/km	kN	m
240RM	18.5 <sup>+0.30</sup>	21.0	63.5	430	70.4	78	10850	12.0	1.6
300RM	20.5 <sup>+0.20</sup>	20.5	64.3	430	71.2	79	11500	15.0	1.6
400RM	23.6 <sup>+0.30</sup>	19.5	65.0	435	71.9	80	12290	20.0	1.6
500RM	26.4 <sup>+0.40</sup>	19.0	66.8	445	73.7	82	13510	25.0	1.6
630RM	30.3 <sup>+0.40</sup>	19.0	70.9	475	77.8	86	15370	31.5	1.7
800RM	34.7 <sup>+0.40</sup>	19.0	75.3	500	82.2	91	17590	40.0	1.8
1000RM	38.3 <sup>+0.40</sup>	19.0	78.9	525	85.8	95	20020	50.0	1.9
1200RMS	41.6 <sup>+0.80</sup>	19.0	83.8	555	90.7	100	22680	60.0	2.0
1400RMS	45.8 <sup>+0.80</sup>	19.0	88.0	580	94.9	104	24960	70.0	2.1
1600RMS	49.6 <sup>+1.2</sup>	19.0	91.8	605	98.7	109	27560	80.0	2.2
1800RMS	53.2 <sup>+1.0</sup>	19.0	95.4	630	102.3	112	30280	90.0	2.3
2000RMS	54.6 <sup>+1.0</sup>	18.0	94.8	625	101.7	112	31480	100.0	2.2
2500RMS	60.0 <sup>+1.0</sup>	18.0	101.2	665	108.5	119	37110	100.0	2.4
3000RMS	68.4 <sup>+1.0</sup>	18.0	109.6	720	116.9	128	44220	100.0	2.6

# HV XLPE CABLE WITH LEAD ALLOY SHEATH

87/150 ÷ 161 (170) kV

## Electrical data

D<sub>e</sub> – Cable diameter

Cables in flat formation, the distance between the cable axes = 2 × D<sub>e</sub>



Cables in trefoil formation, the distance between the cable axes = D<sub>e</sub>



Cross section of conductor	Resistance of conductor 90°C	Electrical field stress at the		Capacitance	Zero reactance	Inductance	
		conductor	insulation screen				
mm <sup>2</sup>	Ω/km	kV/mm		μF/km	Ω/km	Ω/km	
240RM	0.0973	7.50	2.55	0.125	0.101	0.210	0.155
300RM	0.0781	7.40	2.70	0.135	0.095	0.205	0.150
400RM	0.0619	7.35	2.95	0.150	0.087	0.195	0.140
500RM	0.0492	7.20	3.10	0.160	0.082	0.190	0.135
630RM	0.0395	6.90	3.20	0.175	0.076	0.185	0.130
800RM	0.0325	6.65	3.30	0.190	0.071	0.180	0.125
1000RM	0.0275	6.50	3.40	0.205	0.068	0.180	0.120
1200RMS	0.0222	6.30	3.45	0.225	0.066	0.175	0.120
1400RMS	0.0198	6.20	3.50	0.240	0.063	0.175	0.115
1600RMS	0.0182	6.10	3.55	0.250	0.060	0.170	0.110
1800RMS	0.0169	6.00	3.60	0.265	0.058	0.170	0.110
2000RMS	0.0158	6.20	3.85	0.280	0.056	0.165	0.110
2500RMS	0.0140	6.10	3.95	0.305	0.054	0.165	0.105
3000RMS	0.0126	5.95	3.95	0.335	0.051	0.160	0.100

# HV XLPE CABLE WITH LEAD ALLOY SHEATH

87/150 ÷ 161 (170) kV

A2X(F)K2Y according to IEC 60840

NA2X(F)K2Y according to DIN VDE 0276-632

## ALUMINIUM CONDUCTOR

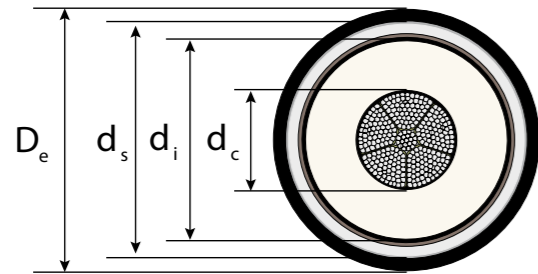

Cross section of conductor	Diameter of conductor	Insulation		Metallic screen		D <sub>e</sub> Outer diameter of cable	Cable weight	Maximum pulling force	Minimal bending radius
		Nominal thickness	Diameter over insulation	Cross section	Diameter over screen				
mm <sup>2</sup>	mm	mm	mm	mm <sup>2</sup>	mm	mm	kg/km	kN	m
240RM	17.9 <sup>+0.10</sup>	21.0	62.9	425	69.8	78	9290	8.4	1.6
300RM	20.0 <sup>+0.30</sup>	20.5	63.8	425	70.7	79	9540	10.5	1.6
400RM	22.9 <sup>+0.30</sup>	19.5	64.3	430	71.2	79	9770	14.0	1.6
500RM	25.7 <sup>+0.40</sup>	19.0	66.1	440	73.0	81	10310	17.5	1.6
630RM	29.3 <sup>+0.50</sup>	19.0	69.9	470	76.8	85	11280	22.1	1.7
800RM	33.0 <sup>+0.50</sup>	19.0	73.6	490	80.5	89	12300	28.0	1.8
1000RM	38.0 <sup>+0.50</sup>	19.0	78.6	520	85.5	94	13650	35.0	1.9
1200RM	42.5 <sup>+0.60</sup>	19.0	83.1	550	90.0	99	14970	42.0	2.0
1200RMS	43.0 <sup>+0.80</sup>	19.0	85.2	565	92.1	101	15390	42.0	2.0
1400RMS	45.1 <sup>+0.80</sup>	19.0	87.3	575	94.2	104	16280	49.0	2.1
1600RMS	48.5 <sup>+1.2</sup>	19.0	90.7	600	97.6	107	17390	56.0	2.1
1800RMS	52.7 <sup>+1.0</sup>	19.0	94.9	625	101.8	112	18750	63.0	2.2
2000RMS	54.5 <sup>+1.0</sup>	18.0	94.7	625	101.6	112	19040	70.0	2.2
2500RMS	59.0 <sup>+1.0</sup>	18.0	100.2	660	107.5	118	21150	87.5	2.4
3000RMS	67.0 <sup>+1.0</sup>	18.0	108.2	710	115.5	127	24370	100.0	2.5

# HV XLPE CABLE WITH LEAD ALLOY SHEATH

87/150 ÷ 161 (170) kV

## Electrical data

D<sub>e</sub> – Cable diameter

Cables in flat formation, the distance between the cable axes = 2 × D<sub>e</sub>



Cables in trefoil formation, the distance between the cable axes = D<sub>e</sub>



Cross section of conductor	Resistance of conductor 90°C	Electrical field stress at the		Capacitance	Zero reactance	Inductance	
		conductor	insulation			Ω/km	Ω/km
mm <sup>2</sup>	Ω/km	kV/mm		μF/km	Ω/km	Ω/km	
240RM	0.1610	7.60	2.55	0.125	0.103	0.215	0.155
300RM	0.1291	7.45	2.65	0.130	0.097	0.205	0.150
400RM	0.1009	7.40	2.90	0.145	0.089	0.200	0.140
500RM	0.0792	7.25	3.10	0.160	0.083	0.195	0.135
630RM	0.0622	7.00	3.20	0.170	0.078	0.190	0.130
800RM	0.0498	6.75	3.30	0.185	0.073	0.185	0.125
1000RM	0.0408	6.50	3.40	0.205	0.068	0.180	0.120
1200RM	0.0359	6.35	3.45	0.220	0.064	0.175	0.115
1200RMS	0.0319	6.25	3.50	0.230	0.065	0.175	0.115
1400RMS	0.0275	6.20	3.50	0.235	0.064	0.175	0.115
1600RMS	0.0242	6.10	3.55	0.250	0.061	0.170	0.115
1800RMS	0.0216	6.00	3.60	0.265	0.059	0.170	0.110
2000RMS	0.0195	6.20	3.85	0.280	0.056	0.165	0.110
2500RMS	0.0168	6.10	3.95	0.300	0.055	0.165	0.105
3000RMS	0.0130	6.00	3.95	0.330	0.051	0.160	0.105



# HV XLPE CABLE WITH LEAD ALLOY SHEATH

127/220 ÷ 230 (245) kV

2X(F)K2Y according to IEC 62067

COPPER CONDUCTOR

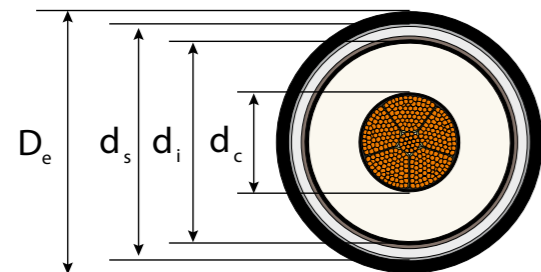

Cross section of conductor	Diameter of conductor	Insulation		Metallic screen		D <sub>e</sub> Outer diameter of cable	Cable weight	Maximum pulling force	Minimal bending radius
		Nominal thickness	Diameter over insulation	Cross section	Diameter over screen				
mm <sup>2</sup>	mm	mm	mm	mm <sup>2</sup>	mm	mm	kg/km	kN	m
400RM	23.6 <sup>+0.30</sup>	24.0	74.8	495	82.1	91	14350	20.0	1.8
500RM	26.4 <sup>+0.40</sup>	23.0	75.4	500	82.7	91	15340	25.0	1.8
630RM	30.3 <sup>+0.40</sup>	22.0	77.5	515	84.8	94	16850	31.5	1.9
800RM	34.7 <sup>+0.40</sup>	22.0	81.3	540	88.6	98	18970	40.0	2.0
1000RM	38.3 <sup>+0.40</sup>	21.0	82.9	550	90.2	99	21010	50.0	2.0
1200RMS	41.6 <sup>+0.80</sup>	21.0	87.8	585	95.1	105	23680	60.0	2.1
1400RMS	45.8 <sup>+0.80</sup>	21.0	92.0	610	99.3	109	26020	70.0	2.2
1600RMS	49.6 <sup>+1.2</sup>	21.0	95.8	635	103.1	113	28620	80.0	2.3
1800RMS	53.2 <sup>+1.0</sup>	21.0	99.4	655	106.7	117	31360	90.0	2.3
2000RMS	54.6 <sup>+1.0</sup>	21.0	100.8	665	108.1	119	33070	100.0	2.4
2500RMS	60.0 <sup>+1.0</sup>	21.5	108.2	715	116.1	127	39120	100.0	2.5
3000RMS	68.4 <sup>+1.0</sup>	21.5	116.6	765	124.5	136	46340	100.0	2.7

# HV XLPE CABLE WITH LEAD ALLOY SHEATH

127/220 ÷ 230 (245) kV

## Electrical data

D<sub>e</sub> – Cable diameter

Cables in flat formation, the distance between the cable axes = 2 × D<sub>e</sub>



Cables in trefoil formation, the distance between the cable axes = D<sub>e</sub>



Cross section of conductor	Resistance of conductor 90°C	Electrical field stress at the conductor insulation screen		Capacitance	Zero reactance	Inductance	
		conductor	insulation			flat formation	trefoil formation
mm <sup>2</sup>	Ω/km	kV/mm		μF/km	Ω/km	Ω/km	
400RM	0.0619	9.25	3.30	0.130	0.096	0.205	0.145
500RM	0.0492	9.20	3.60	0.145	0.089	0.200	0.140
630RM	0.0395	9.05	3.95	0.160	0.082	0.190	0.135
800RM	0.0325	8.75	4.05	0.175	0.076	0.185	0.130
1000RM	0.0275	8.80	4.35	0.190	0.071	0.180	0.125
1200RMS	0.0222	8.55	4.45	0.205	0.069	0.180	0.120
1400RMS	0.0198	8.35	4.55	0.220	0.066	0.175	0.115
1600RMS	0.0182	8.20	4.60	0.235	0.063	0.175	0.115
1800RMS	0.0169	8.10	4.65	0.245	0.061	0.170	0.110
2000RMS	0.0158	8.05	4.70	0.250	0.060	0.170	0.110
2500RMS	0.0140	7.70	4.65	0.265	0.059	0.170	0.110
3000RMS	0.0126	7.55	4.75	0.290	0.055	0.165	0.105

# HV XLPE CABLE WITH LEAD ALLOY SHEATH

127/220 ÷ 230 (245) kV

A2X(F)K2Y according to IEC 62067

## ALUMINIUM CONDUCTOR

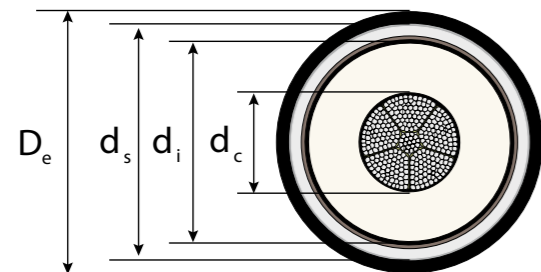

Cross section of conductor	Diameter of conductor	Insulation		Metallic screen		D <sub>e</sub> Outer diameter of cable	Cable weight	Maximum pulling force	Minimal bending radius
		Nominal thickness	Diameter over insulation	Cross section	Diameter over screen				
mm <sup>2</sup>	mm	mm	mm	mm <sup>2</sup>	mm	mm	kg/km	kN	m
400RM	22.9 <sup>+0.30</sup>	24.0	74.1	490	81.4	90	11820	14.0	1.8
500RM	25.7 <sup>+0.40</sup>	23.0	74.7	495	82.0	91	12130	17.5	1.8
630RM	29.3 <sup>+0.50</sup>	22.0	76.5	510	83.8	92	12720	22.1	1.9
800RM	33.0 <sup>+0.50</sup>	22.0	79.6	530	86.9	96	13680	28.0	1.9
1000RM	38.0 <sup>+0.50</sup>	21.0	82.6	550	89.9	99	14640	35.0	2.0
1200RM	42.5 <sup>+0.60</sup>	21.0	87.1	580	94.4	104	15960	42.0	2.1
1200RMS	43.0 <sup>+0.80</sup>	21.0	89.2	590	96.5	106	16430	42.0	2.1
1400RMS	45.1 <sup>+0.80</sup>	21.0	91.3	605	98.6	108	17330	49.0	2.2
1600RMS	48.5 <sup>+1.2</sup>	21.0	94.7	625	102.0	112	18470	56.0	2.2
1800RMS	52.7 <sup>+1.0</sup>	21.0	98.9	650	106.2	116	19820	63.0	2.3
2000RMS	54.5 <sup>+1.0</sup>	21.0	100.7	665	108.0	118	20620	70.0	2.4
2500RMS	59.0 <sup>+1.0</sup>	21.5	107.2	710	115.1	126	23100	87.5	2.5
3000RMS	67.0 <sup>+1.0</sup>	21.5	115.2	760	123.1	135	26430	100.0	2.7

# HV XLPE CABLE WITH LEAD ALLOY SHEATH

127/220 ÷ 230 (245) kV

## Electrical data

D<sub>e</sub> – Cable diameter

Cables in flat formation, the distance between the cable axes = 2 × D<sub>e</sub>



Cables in trefoil formation, the distance between the cable axes = D<sub>e</sub>



Cross section of conductor	Resistance of conductor 90°C	Electrical field stress at the		Capacitance	Zero reactance	Inductance	
		conductor screen	insulation				
mm <sup>2</sup>	Ω/km	kV/mm		μF/km	Ω/km	Ω/km	
400RM	0.1009	9.35	3.30	0.130	0.097	0.205	0.150
500RM	0.0792	9.30	3.55	0.140	0.090	0.200	0.140
630RM	0.0622	9.15	3.90	0.160	0.083	0.195	0.135
800RM	0.0498	8.90	4.00	0.170	0.078	0.190	0.130
1000RM	0.0408	8.85	4.35	0.190	0.071	0.180	0.125
1200RM	0.0359	8.60	4.45	0.205	0.067	0.180	0.120
1200RMS	0.0319	8.50	4.50	0.210	0.068	0.180	0.120
1400RMS	0.0275	8.40	4.55	0.220	0.066	0.175	0.120
1600RMS	0.0242	8.25	4.60	0.230	0.064	0.175	0.115
1800RMS	0.0216	8.10	4.65	0.245	0.061	0.170	0.115
2000RMS	0.0195	8.05	4.70	0.250	0.060	0.170	0.110
2500RMS	0.0168	7.75	4.65	0.260	0.059	0.170	0.110
3000RMS	0.0130	7.60	4.75	0.285	0.055	0.165	0.105

# HV XLPE CABLE WITH LEAD ALLOY SHEATH

220/380 ÷ 400 (420) kV

2X(F)K2Y according to IEC 62067

COPPER CONDUCTOR

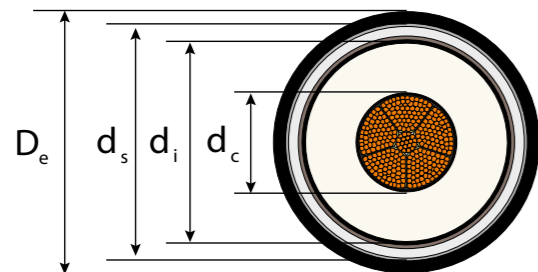

Cross section of conductor	Diameter of conductor	Insulation		Metallic screen		D <sub>e</sub> Outer diameter of cable	Cable weight	Maximum pulling force	Minimal bending radius
		Nominal thickness	Diameter over insulation	Cross section	Diameter over screen				
mm <sup>2</sup>	mm	mm	mm	mm <sup>2</sup>	mm	mm	kg/km	kN	m
630RM	30.3 <sup>+0.40</sup>	32.0	98.5	655	106.4	117	21840	31.5	2.3
800RM	34.7 <sup>+0.40</sup>	31.0	100.9	670	108.8	119	23760	40.0	2.4
1000RM	38.3 <sup>+0.40</sup>	30.0	102.5	680	110.4	121	25860	50.0	2.4
1200RMS	41.6 <sup>+0.80</sup>	28.0	101.8	675	109.7	120	27250	60.0	2.4
1400RMS	45.8 <sup>+0.80</sup>	27.0	104.0	690	111.9	123	29140	70.0	2.5
1600RMS	49.6 <sup>+1.2</sup>	27.0	107.8	710	115.7	127	31850	80.0	2.5
1800RMS	53.2 <sup>+1.0</sup>	27.0	111.4	735	119.3	131	34670	90.0	2.6
2000RMS	54.6 <sup>+1.0</sup>	27.0	112.8	745	120.7	132	36370	100.0	2.6
2500RMS	60.0 <sup>+1.0</sup>	27.0	119.2	785	127.1	139	42130	100.0	2.8

## Electrical data

D<sub>e</sub> – Cable diameter

Cables in flat formation, the distance between the cable axes = 2 × D<sub>e</sub>



Cables in trefoil formation, the distance between the cable axes = D<sub>e</sub>



# HV XLPE CABLE WITH LEAD ALLOY SHEATH

220/380 ÷ 400 (420) kV

Cross section of conductor	Resistance of conductor 90°C	Electrical field stress at the		Capacitance	Zero reactance	Inductance	
		conductor screen	insulation			Ω/km	Ω/km
mm <sup>2</sup>	Ω/km	kV/mm		μF/km	Ω/km	Ω/km	
630RM	0.0395	12.20	4.30	0.130	0.096	0.205	0.145
800RM	0.0325	11.90	4.60	0.140	0.089	0.200	0.140
1000RM	0.0275	11.80	4.90	0.155	0.084	0.195	0.135
1200RMS	0.0222	12.05	5.45	0.170	0.078	0.190	0.130
1400RMS	0.0198	12.05	5.80	0.185	0.073	0.185	0.125
1600RMS	0.0182	11.80	5.90	0.195	0.070	0.180	0.120
1800RMS	0.0169	11.60	6.00	0.205	0.066	0.175	0.120
2000RMS	0.0158	11.50	6.00	0.210	0.067	0.175	0.120
2500RMS	0.0140	11.20	6.15	0.225	0.064	0.175	0.115

# HV XLPE CABLE WITH LEAD ALLOY SHEATH

220/380 ÷ 400 (420) kV

A2X(F)K2Y according to IEC 62067

## ALUMINIUM CONDUCTOR

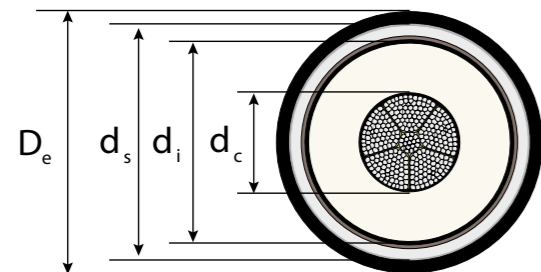

Cross section of conductor	Diameter of conductor	Insulation		Metallic screen		D <sub>e</sub> Outer diameter of cable	Cable weight	Maximum pulling force	Minimal bending radius
		Nominal thickness	Diameter over insulation	Cross section	Diameter over screen				
mm <sup>2</sup>	mm	mm	mm	mm <sup>2</sup>	mm	mm	kg/km	kN	m
630RM	29.3 <sup>+0.50</sup>	32.0	97.5	645	105.4	116	17700	22.1	2.3
800RM	33.0 <sup>+0.50</sup>	31.0	99.2	660	107.1	118	18420	28.0	2.4
1000RM	38.0 <sup>+0.50</sup>	30.0	102.2	675	110.1	121	19480	35.0	2.4
1200RM	42.5 <sup>+0.60</sup>	28.0	102.7	680	110.6	121	19930	42.0	2.4
1200RMS	43.0 <sup>+0.80</sup>	28.0	103.2	685	111.1	122	20010	42.0	2.4
1400RMS	45.1 <sup>+0.80</sup>	27.0	103.3	685	111.2	122	20440	49.0	2.4
1600RMS	48.5 <sup>+1.2</sup>	27.0	106.7	705	114.6	125	21640	56.0	2.5
1800RMS	52.7 <sup>+1.0</sup>	27.0	110.9	730	118.8	130	23120	63.0	2.6
2000RMS	54.5 <sup>+1.0</sup>	27.0	112.7	745	120.6	132	23920	70.0	2.6
2500RMS	59.0 <sup>+1.0</sup>	27.0	118.2	775	126.1	138	26100	87.5	2.8

# HV XLPE CABLE WITH LEAD ALLOY SHEATH

220/380 ÷ 400 (420) kV

## Electrical data

D<sub>e</sub> – Cable diameter

Cables in flat formation, the distance between the cable axes = 2 × D<sub>e</sub>



Cables in trefoil formation, the distance between the cable axes = D<sub>e</sub>



Cross section of conductor	Resistance of conductor 90°C	Electrical field stress at the		Capacitance	Zero reactance	Inductance	
		conductor	insulation			Ω/km	Ω/km
mm <sup>2</sup>	Ω/km	kV/mm		μF/km	Ω/km	Ω/km	
630RM	0.0622	12.30	4.25	0.125	0.098	0.205	0.150
800RM	0.0498	12.10	4.55	0.140	0.091	0.200	0.145
1000RM	0.0408	11.80	4.90	0.155	0.084	0.195	0.135
1200RM	0.0359	12.00	5.45	0.170	0.077	0.185	0.130
1200RMS	0.0319	11.95	5.45	0.170	0.077	0.185	0.130
1400RMS	0.0275	12.10	5.80	0.180	0.074	0.185	0.125
1600RMS	0.0242	11.85	5.85	0.190	0.071	0.180	0.120
1800RMS	0.0216	11.60	5.95	0.200	0.068	0.180	0.120
2000RMS	0.0195	11.50	6.00	0.205	0.067	0.175	0.120
2500RMS	0.0168	11.25	6.10	0.220	0.065	0.175	0.115



# Ampacity

# COPPER 26/45 ÷ 47 (52) kV, 36/60 ÷ 69 (72.5) kV

Current rating for single-core cables – amperes

Cross section of conductor



Configurations

SPP; CB   Both-ends   SPP; CB   Both-ends   SPP; CB   Both-ends   SPP; CB   Both-ends

Cables in earth

Cables in air

mm <sup>2</sup>	Cables in earth				Cables in air				Cables in earth				Cables in air			
	65°C	90°C	65°C	90°C	65°C	90°C	65°C	90°C	65°C	90°C	65°C	90°C	65°C	90°C	65°C	90°C
95RM	285	340	275	330	275	325	270	325	310	415	295	400	265	360	265	360
120RM	325	390	305	370	310	370	305	365	355	480	335	455	305	415	300	410
150RM	365	440	340	415	350	415	340	410	405	545	380	515	345	470	340	465
185RM	415	495	380	460	390	470	385	460	460	625	425	580	395	540	390	530
240RM	480	575	425	520	455	545	440	535	545	740	490	675	465	635	455	625
300RM	540	650	465	570	515	615	495	600	625	850	545	755	530	730	515	710
400RM	620	745	510	625	585	700	560	675	730	985	615	855	615	845	595	820
500RM	705	850	550	685	660	795	625	755	845	1145	685	955	710	975	680	935
630RM	805	970	595	740	740	895	695	845	980	1330	755	1060	815	1120	770	1070
800RM	905	1090	630	790	825	1000	760	930	1125	1535	825	1170	925	1275	865	1205
1000RM	995	1210	660	825	900	1090	815	1005	1255	1720	880	1255	1025	1420	945	1325
1200RMS	1105	1335	650	820	1020	1235	875	1075	1405	1915	895	1275	1175	1625	1035	1455
1400RMS	1185	1435	665	840	1085	1320	915	1130	1530	2090	930	1335	1270	1760	1105	1550
1600RMS	1250	1520	680	860	1140	1385	945	1175	1640	2245	965	1390	1355	1880	1160	1640
1800RMS	1310	1590	690	870	1180	1440	970	1205	1735	2380	990	1430	1425	1980	1210	1715
2000RMS	1360	1660	695	880	1220	1490	990	1235	1810	2490	1010	1455	1480	2060	1245	1765
2500RMS	1470	1790	710	900	1300	1595	1035	1295	1980	2720	1050	1520	1605	2240	1325	1885
3000RMS	1580	1930	725	920	1380	1695	1075	1345	2180	3005	1100	1590	1750	2440	1410	2015

SPB – Single Point Bonding; CB – Cross-bonding Both-ends; BE – Both-ends bonding

# ALUMINIUM 26/45 ÷ 47 (52) kV, 36/60 ÷ 69 (72.5) kV

Current rating for single-core cables – amperes

Cross section of conductor



Configurations

SPP; CB   Both-ends   SPP; CB   Both-ends   SPP; CB   Both-ends   SPP; CB   Both-ends

Cables in earth

Cables in air

mm <sup>2</sup>	Cables in earth				Cables in air				Cables in earth				Cables in air			
	65°C	90°C	65°C	90°C	65°C	90°C	65°C	90°C	65°C	90°C	65°C	90°C	65°C	90°C	65°C	90°C
95RM	220	265	215	260	210	255	210	250	235	320	230	315	205	280	205	275
120RM	250	300	245	290	240	285	235	285	275	370	265	360	235	320	235	320
150RM	280	340	270	325	270	320	265	320	310	420	300	405	265	365	265	360
185RM	320	385	305	365	305	365	300	360	360	485	340	460	305	415	305	415
240RM	370	445	345	420	355	425	345	420	420	570	395	540	360	490	355	485
300RM	420	505	385	465	400	480	390	470	485	655	445	610	415	565	405	555
400RM	485	580	430	525	455	550	445	535	565	765	505	695	480	660	470	645
500RM	555	665	455	580	520	625	505	610	660	890	575	790	560	765	545	745
630RM	635	765	520	640	595	715	570	690	770	1045	645	895	650	890	625	865
800RM	725	870	560	695	670	810	635	770	890	1210	715	1000	745	1025	715	985
1000RM	815	980	600	745	750	905	700	850	1025	1395	790	1110	850	1175	805	1115
1200RM	885	1070	595	745	805	975	730	895	1135	1545	810	1145	935	1290	865	1205
1200RMS	930	1115	610	760	870	1040	780	950	1185	1605	830	1170	1010	1375	925	1275
1400RMS	1005	1210	630	790	940	1130	830	1015	1300	1755	870	1235	1100	1505	995	1380
1600RMS	1085	1300	650	815	1005	1210	875	1070	1415	1910	910	1290	1195	1635	1065	1480
1800RMS	1160	1395	665	835	1075	1295	920	1130	1535	2080	950	1350	1295	1775	1140	1590
2000RMS	1225	1470	675	850	1130	1360	955	1175	1630	2205	975	1390	1370	1880	1190	1665
2500RMS	1335	1605	695	875	1225	1475	1015	1245	1790	2425	1020	1460	1505	2065	1285	1800
3000RMS	1540	1855	720	910	1400	1690	1105	1370	2120	2875	1085	1565	1765	2425	1445	2040

SPB – Single Point Bonding; CB – Cross-bonding Both-ends; BE – Both-ends bonding

# COPPER 64/110 ÷ 115 (123) kV, 87/150 ÷ 161 (170) kV

Current rating for single-core cables – amperes

Cross section of conductor

Configurations

mm <sup>2</sup>	Cables in earth				Cables in air				Cables in earth				Cables in air			
	SPP; CB	Both-ends	SPP; CB	Both-ends	SPP; CB	Both-ends	SPP; CB	Both-ends	SPP; CB	Both-ends	SPP; CB	Both-ends	SPP; CB	Both-ends	SPP; CB	Both-ends
150RM	360	435	325	395	345	415	335	405	390	520	360	490	350	470	345	465
185RM	410	490	355	435	390	465	375	450	445	595	405	545	400	540	390	525
240RM	475	570	395	485	450	545	430	520	530	710	465	630	470	635	455	615
300RM	540	645	430	525	510	615	480	580	610	815	515	705	535	725	510	700
400RM	615	740	465	570	580	700	535	650	705	950	570	790	620	840	585	800
500RM	700	845	500	615	660	795	595	725	815	1100	630	875	715	970	660	910
630RM	800	965	530	660	745	900	660	805	945	1275	695	970	820	1120	750	1030
800RM	900	1090	560	695	830	1005	715	880	1085	1465	755	1055	930	1275	835	1155
1000RM	995	1205	580	725	910	1105	765	945	1215	1650	800	1130	1035	1415	905	1265
1200RMS	1100	1330	605	755	1020	1235	825	1020	1355	1830	850	1200	1170	1605	995	1390
1400RMS	1180	1430	620	775	1085	1320	860	1065	1475	2000	885	1255	1265	1740	1055	1485
1600RMS	1250	1515	630	790	1140	1390	885	1100	1575	2140	915	1300	1350	1855	1110	1560
1800RMS	1305	1590	640	805	1185	1450	910	1135	1665	2270	940	1340	1420	1955	1150	1625
2000RMS	1360	1655	650	815	1230	1500	930	1160	1740	2375	960	1365	1475	2035	1185	1675
2500RMS	1465	1790	665	835	1310	1605	965	1205	1900	2595	1000	1430	1600	2210	1255	1780
3000RMS	1580	1930	680	855	1395	1710	1000	1255	2095	2860	1050	1495	1740	2410	1330	1895

SPB – Single Point Bonding; CB – Cross-bonding Both-ends; BE – Both-ends bonding

# ALUMINIUM 64/110 ÷ 115 (123) kV, 87/150 ÷ 161 (170) kV

Current rating for single-core cables – amperes

Cross section of conductor

Configurations

mm <sup>2</sup>	Cables in earth				Cables in air				Cables in earth				Cables in air			
	SPP; CB	Both-ends	SPP; CB	Both-ends	SPP; CB	Both-ends	SPP; CB	Both-ends	SPP; CB	Both-ends	SPP; CB	Both-ends	SPP; CB	Both-ends	SPP; CB	Both-ends
150RM	280	335	265	320	265	320	260	315	300	400	285	385	270	365	265	360
185RM	315	380	295	355	300	360	295	355	345	460	325	435	310	415	305	410
240RM	370	440	330	400	350	420	340	410	410	545	375	510	365	490	355	480
300RM	420	500	370	450	395	475	385	465	470	630	430	580	415	560	405	550
400RM	480	575	400	490	455	545	430	520	550	735	480	655	485	655	465	635
500RM	550	660	435	535	520	625	485	590	640	855	535	735	560	760	535	730
630RM	635	760	475	585	595	715	545	665	745	1000	600	825	650	885	610	840
800RM	720	865	510	630	670	810	605	740	860	1155	660	920	750	1015	695	955
1000RM	810	980	540	670	750	905	665	815	990	1335	725	1010	855	1165	780	1075
1200RM	885	1065	560	695	810	980	705	865	1095	1475	770	1080	935	1275	840	1165
1200RMS	925	1110	575	710	865	1040	740	905	1140	1530	790	1105	1000	1355	890	1225
1400RMS	1005	1205	590	735	935	1125	785	960	1250	1675	830	1160	1090	1475	955	1320
1600RMS	1080	1295	650	815	1005	1205	870	1065	1360	1820	915	1285	1180	1600	1060	1465
1800RMS	1155	1390	620	775	1070	1285	865	1065	1475	1980	900	1270	1280	1735	1080	1505
2000RMS	1220	1465	630	790	1130	1355	895	1100	1560	2100	925	1305	1350	1840	1130	1575
2500RMS	1330	1600	650	815	1220	1470	945	1165	1720	2310	970	1370	1485	2020	1210	1695
3000RMS	1535	1850	680	850	1395	1685	1020	1265	2025	2730	1035	1475	1735	2365	1355	1905

SPB – Single Point Bonding; CB – Cross-bonding Both-ends; BE – Both-ends bonding

# ALUMINIUM 127/220 ÷ 230 (245) kV

Current rating for single-core cables – amperes

Cross section of conductor	Configurations															
	SPP; CB		Both-ends		SPP; CB		Both-ends		SPP; CB		Both-ends		SPP; CB		Both-ends	
	Cables in earth								Cables in air							
mm <sup>2</sup>	65°C	90°C	65°C	90°C	65°C	90°C	65°C	90°C	65°C	90°C	65°C	90°C	65°C	90°C	65°C	90°C
400RM	470	570	395	480	445	540	420	510	530	705	470	635	475	640	455	620
500RM	540	650	430	525	510	615	470	570	615	825	525	720	550	745	520	710
630RM	620	750	465	575	580	705	525	645	720	965	590	810	640	865	595	815
800RM	705	855	500	615	660	800	580	710	830	1115	650	900	735	995	670	925
1000RM	795	965	530	655	735	895	635	780	955	1285	715	995	835	1140	750	1040
1200RM	865	1050	550	685	795	965	670	830	1050	1420	760	1060	915	1255	810	1130
1200RMS	905	1090	560	695	845	1020	700	860	1105	1480	780	1085	975	1325	850	1180
1400RMS	980	1185	580	715	910	1105	735	910	1205	1615	820	1140	1060	1445	910	1265
1600RMS	1055	1275	595	740	975	1185	770	955	1310	1760	855	1195	1150	1565	970	1350
1800RMS	1130	1365	610	760	1040	1265	805	1000	1420	1910	895	1255	1245	1695	1030	1435
2000RMS	1190	1440	620	770	1095	1330	830	1035	1505	2025	920	1290	1315	1795	1070	1500
2500RMS	1295	1570	640	795	1185	1440	870	1085	1645	2220	965	1355	1440	1965	1145	1605
3000RMS	1495	1815	665	830	1350	1650	935	1175	1940	2620	1035	1460	1680	2300	1270	1795

SPB – Single Point Bonding; CB – Cross-bonding Both-ends; BE – Both-ends bonding

# COPPER 220/380 ÷ 400 (420) kV, 290/500 (550) kV

Current rating for single-core cables – amperes

Cross section of conductor	Configurations															
	SPP; CB		Both-ends		SPP; CB		Both-ends		SPP; CB		Both-ends		SPP; CB		Both-ends	
	Cables in earth								Cables in air							
mm <sup>2</sup>	65°C	90°C	65°C	90°C	65°C	90°C	65°C	90°C	65°C	90°C	65°C	90°C	65°C	90°C	65°C	90°C
630RM	740	915	520	650	690	855	600	750	835	1135	675	940	760	1045	700	975
800RM	835	1030	545	685	765	955	650	820	960	1305	740	1035	860	1190	780	1090
1000RM	920	1140	565	715	840	1050	690	880	1070	1465	790	1115	955	1330	845	1195
1200RMS	1010	1255	585	740	925	1160	725	925	1195	1635	840	1185	1070	1485	915	1300
1400RMS	1080	1345	595	760	980	1235	750	965	1300	1785	875	1245	1155	1610	970	1380
1600RMS	1135	1425	605	770	1025	1300	770	995	1390	1915	905	1290	1225	1720	1010	1450
1800RMS	1185	1490	610	780	1065	1350	785	1015	1470	2035	930	1330	1290	1815	1050	1510
2000RMS	1230	1550	620	790	1100	1400	800	1035	1535	2125	950	1355	1340	1890	1075	1555
2500RMS	1320	1675	630	805	1170	1495	820	1070	1685	2340	985	1415	1455	2065	1135	1650
3000RMS	1415	1800	640	825	1235	1590	840	1105	1855	2575	1035	1490	1580	2245	1205	1760

SPB – Single Point Bonding; CB – Cross-bonding Both-ends; BE – Both-ends bonding



# ALUMINIUM 220/380 ÷ 400 (420) kV, 290/500 (550) kV

Current rating for single-core cables – amperes

Cross section of conductor



Configurations

SPP; CB    Both-ends    SPP; CB    Both-ends    SPP; CB    Both-ends    SPP; CB    Both-ends

mm <sup>2</sup>	Cables in earth								Cables in air							
	65°C	90°C	65°C	90°C	65°C	90°C	65°C	90°C	65°C	90°C	65°C	90°C	65°C	90°C	65°C	90°C
630RM	585	720	460	570	545	675	500	620	660	890	570	785	600	820	570	785
800RM	665	820	490	615	615	765	550	690	760	1030	660	880	685	945	640	890
1000RM	750	925	520	655	690	855	600	755	870	1185	700	975	785	1080	720	1005
1200RM	810	1005	540	680	740	925	635	800	960	1310	745	1045	860	1190	775	1090
1200RMS	850	1045	550	695	780	970	655	830	1005	1365	765	1070	905	1245	815	1135
1400RMS	915	1135	565	715	840	1050	690	875	1100	1495	805	1130	985	1360	870	1220
1600RMS	980	1215	580	735	900	1120	720	920	1195	1630	845	1190	1065	1475	925	1305
1800RMS	1045	1300	590	750	955	1195	745	955	1300	1770	880	1245	1150	1600	980	1390
2000RMS	1105	1370	600	765	1000	1255	770	990	1375	1875	905	1285	1215	1690	1020	1450
2500RMS	1195	1490	615	780	1075	1355	800	1035	1520	2075	950	1350	1335	1860	1090	1560
3000RMS	1375	1720	640	815	1220	1550	860	1115	1785	2450	1020	1460	1555	2175	1210	1750

SPB – Single Point Bonding; CB – Cross-bonding Both-ends; BE – Both-ends bonding

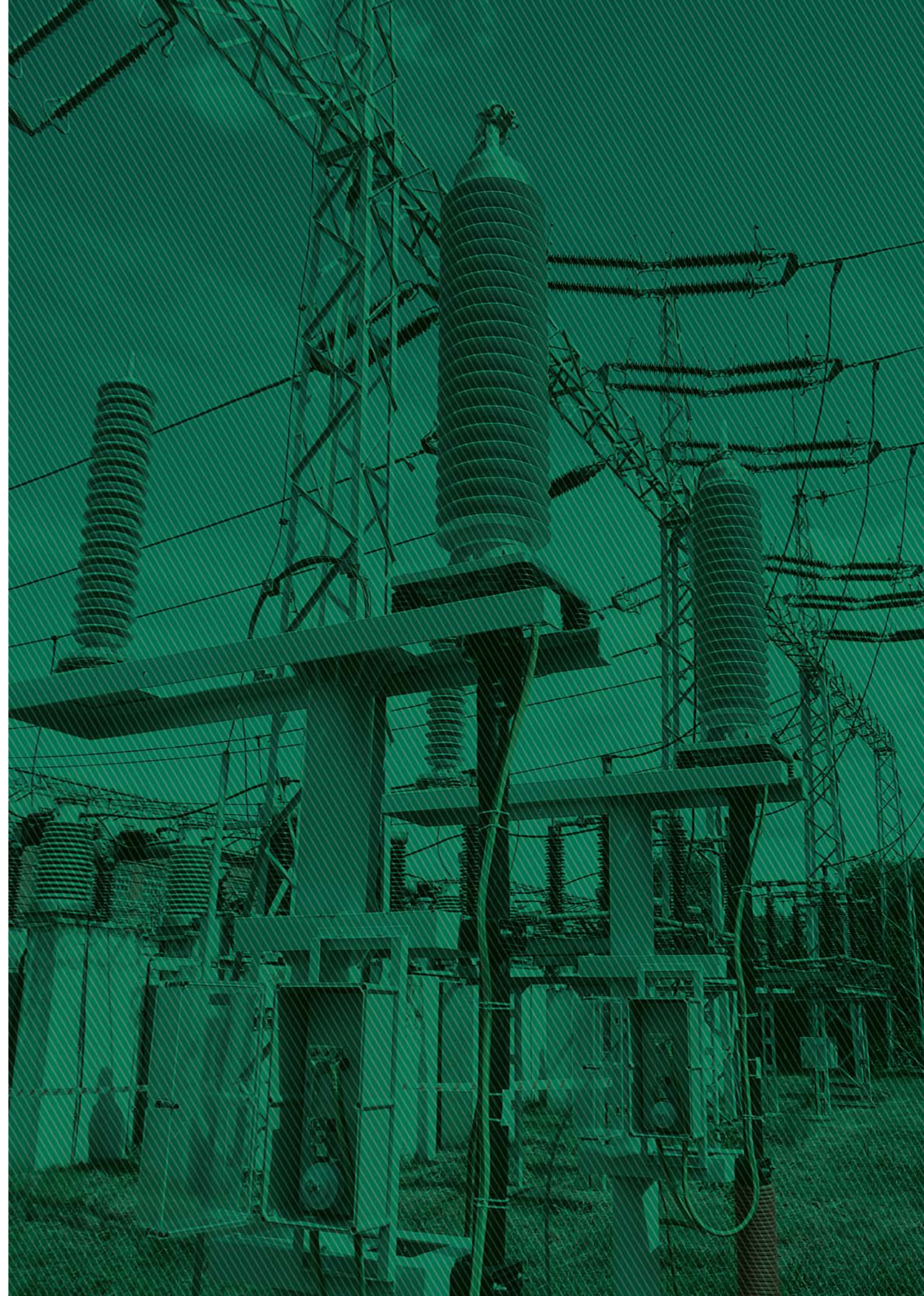



# Installation correction factors

Depth of laying factor – "d"

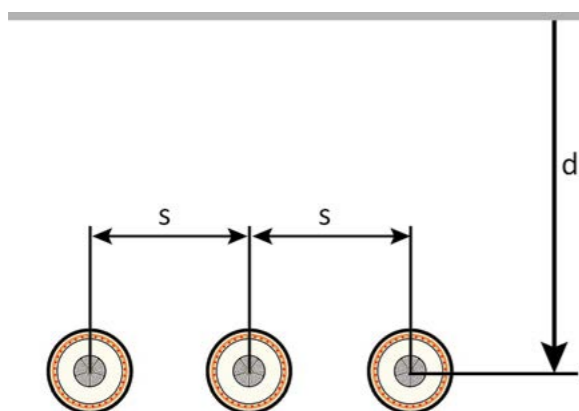

Ground surface to cable axis

Distance between circuits – "t"

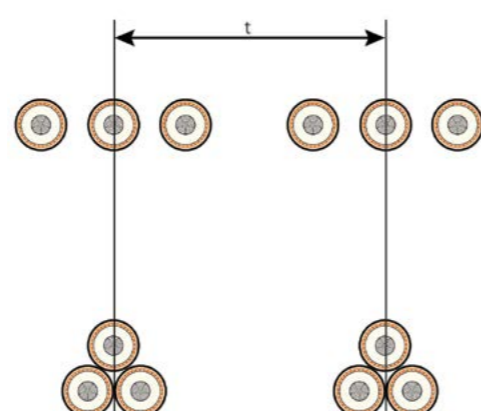

Distance between each circuit axis

### Installation and environmental correction factor tables for the calculation of cable current ratings

Laying depth in earth

Cross sectional area of conductor mm <sup>2</sup>	Laying depth							
	m							
	0.5	0.7	0.9	1.0	1.2	1.5	2.0	3.0
150-630	1.09	1.04	1.01	1.00	0.98	0.96	0.93	0.90
800-1400	1.11	1.05	1.01	1.00	0.98	0.95	0.92	0.88
1600-3000	1.12	1.06	1.02	1.00	0.97	0.95	0.91	0.87

Ground thermal resistivity

Cross sectional area of conductor mm <sup>2</sup>	Thermal resistivity of ground							
	Km/W							
	0.5	0.7	0.9	1.0	1.2	1.5	2.0	3.0
150-630	1.26	1.13	1.04	1.00	0.93	0.85	0.76	0.64
800-1400	1.30	1.15	1.04	1.00	0.93	0.84	0.74	0.61
1600-3000	1.32	1.16	1.05	1.00	0.92	0.84	0.73	0.61

Ground temperature

Cross sectional area of conductor mm <sup>2</sup>	Ground temperature							
	°C							
	5	10	15	20	25	30	35	40
150-630	1.10	1.07	1.04	1.00	0.96	0.93	0.89	0.85
800-1400	1.10	1.07	1.04	1.00	0.96	0.93	0.89	0.85
1600-3000	1.10	1.07	1.04	1.00	0.96	0.93	0.89	0.85

Air temperature

Cross sectional area of conductor mm <sup>2</sup>	Air temperature							
	°C							
	20	25	30	35	40	45	50	55
150-630	1.14	1.10	1.05	1.00	0.95	0.89	0.84	0.78
800-1400	1.15	1.10	1.05	1.00	0.95	0.89	0.84	0.77
1600-3000	1.15	1.10	1.05	1.00	0.95	0.89	0.83	0.77

### Distance between cable axis in flat formation

Cross sectional area of conductor mm <sup>2</sup>	Distance between cables axes in flat formation mm					
	D	2D	200	300	500	1000
150-630	0.95	1.00	1.03	1.07	1.11	1.18
800-1400	0.92	1.00	1.02	1.06	1.12	1.20
1600-3000	0.90	1.00	1.01	1.05	1.11	1.20

\* D - cable outer diameter [mm]

### Distance between circuit axis and the number of circuits

Distance between circuits axes "t" m	Cross sectional area of conductor mm <sup>2</sup>	Number of circuits					
		1	2	3	4	5	6
0.5	150-630	1.00	0.86	0.78	0.74	0.71	0.69
	800-1400	1.00	0.83	0.75	0.71	0.67	0.65
	1600-3000	-	-	-	-	-	-
1.0	150-630	1.00	0.92	0.86	0.83	0.81	0.80
	800-1400	1.00	0.90	0.84	0.81	0.79	0.77
	1600-3000	1.00	0.89	0.82	0.79	0.77	0.75
1.5	150-630	1.00	0.94	0.90	0.89	0.87	0.87
	800-1400	1.00	0.93	0.89	0.87	0.85	0.85
	1600-3000	1.00	0.93	0.87	0.86	0.84	0.83
2.0	150-630	1.00	0.96	0.93	0.92	0.91	0.91
	800-1400	1.00	0.95	0.92	0.91	0.90	0.89
	1600-3000	1.00	0.95	0.91	0.90	0.89	0.88

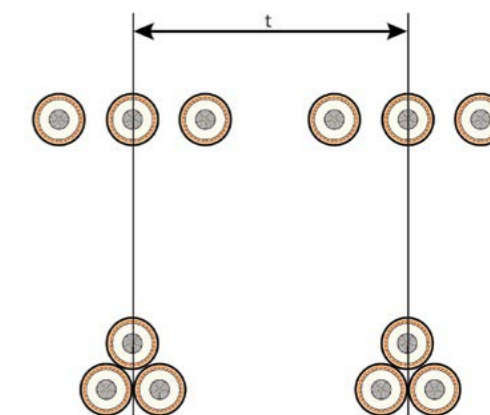

### Cross sectional area of metallic screen with both-ends bonding

Flat formation

Cross sectional area of conductor mm <sup>2</sup>	Metallic screen cross sectional area mm <sup>2</sup>					
	50	95	150	200	250	300
150-630	1.04	1.00	0.98	0.99	1.00	1.01
800-1400	1.08	1.00	0.97	0.98	1.00	1.02
1600-3000	1.08	1.00	0.98	0.99	1.01	1.03

Trefoil formation

Cross sectional area of conductor mm <sup>2</sup>	Metallic screen cross sectional area mm <sup>2</sup>					
	50	95	150	200	250	300
150-630	1.02	1.00	0.98	0.98	0.97	0.97
800-1400	1.04	1.00	0.96	0.94	0.93	0.92
1600-3000	1.06	1.00	0.95	0.92	0.91	0.89

## Cable laid in ducts

Cross sectional area of conductor mm <sup>2</sup>	Flat formation			Trefoil formation		
	Ducts (wall thickness 20 mm)					
	Directly in ground	Common, inner diameter 2.16 × 1.6 × D	Individual, inner diameter 1.6 × D	Directly in ground	Common, inner diameter 2.16 × 1.6 × D	Individual, inner diameter 1.6 × D
150 - 630	1.00	–	0.92	1.00	0.94	0.93
800 - 1400	1.00	–	0.92	1.00	0.95	0.99
1600 - 3000	1.00	–	0.92	1.00	0.98	1.01

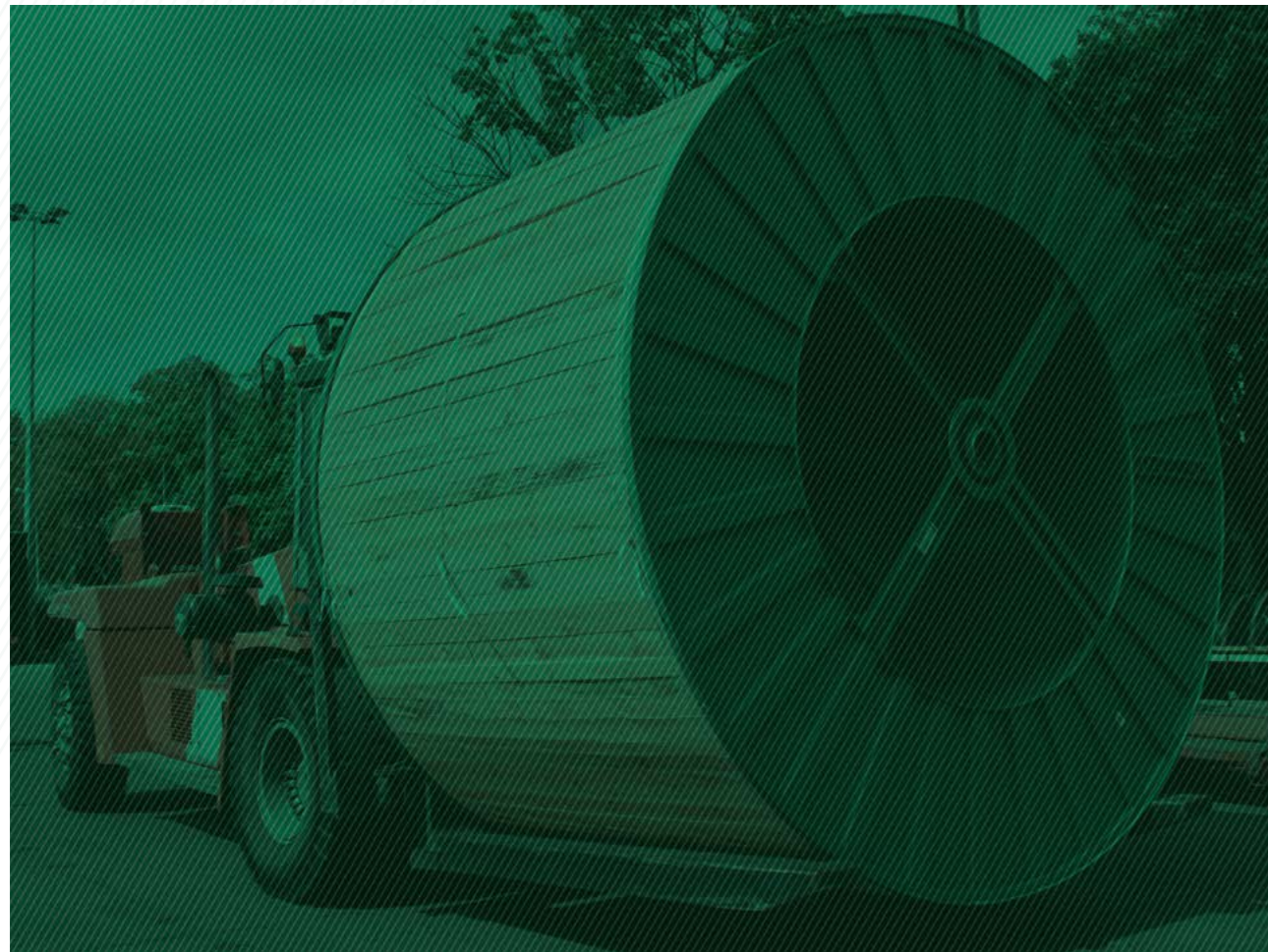

## Worked example

Two trefoil circuits of 110 kV cables:

- Conductor cross sectional area – 1000 mm<sup>2</sup> Cu
- Metallic screen cross sectional area – 95 mm<sup>2</sup>
- Ground depth of laying – 1.5 m
- Ground thermal resistivity – 0.9 K × m/W
- Ground temperature – 30 °C
- Distance between circuit axis – 0.5 m
- Single point bonding
- Load factor LF=0.9
- Trefoil formation (max. conductor temperature 90 °C)

Current rating from catalogue for standard conditions has to be multiplied by correction factors from above tables.

Current rating from catalogue for 'standard' conditions: I = 1105 Amps

Current rating corrected for actual environmental and installation conditions: I = 1105 Amps × 0.95 × 0.93 × 1.04 × 0.83 × 1.07 = 902 Amps

Above results are only indicative for the calculation of conductor cross sectional area. Initial calculations should be verified use of current rating software to confirm the correct conductor cross sectional area.

## Example of current rating calculation using CymCap software, for above conditions:

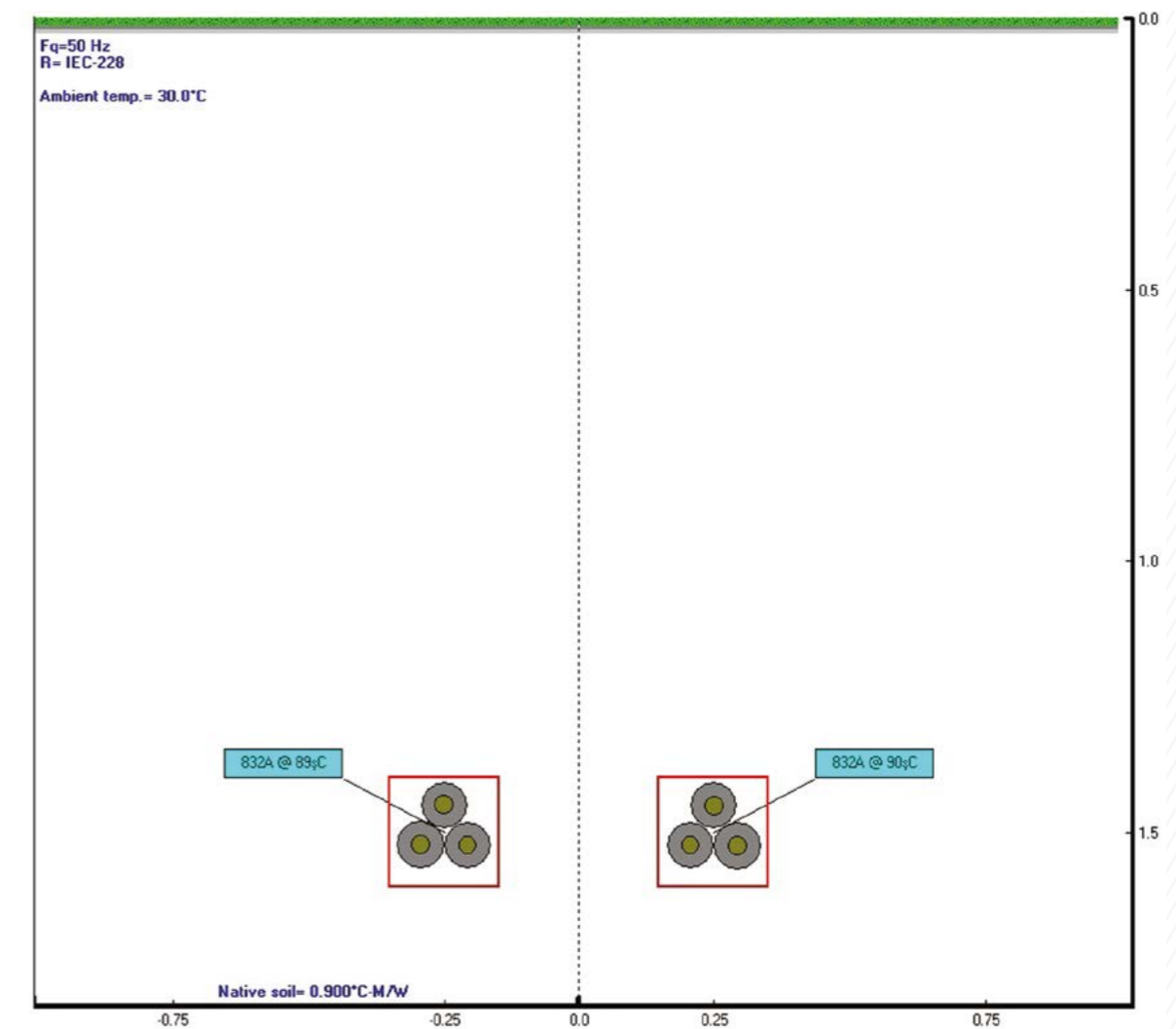

## Equations

Dynamic forces during short circuit

$$F = \frac{0.2}{s} \cdot I_{max}^2$$

where:

$I_{max}$  –  $2.5 \times I_{zw}$  kA

$I_{zw}$  – short circuit current kA

$s$  – distance between cable axes m

$F$  – maximum force N/m

Capacitance

$$C = \frac{E_r}{18 \cdot \ln \cdot \left( \frac{r_e}{r_i} \right)}$$

where:

$E_r$  – permittivity of the insulation

$r_e$  – external radius of the insulation mm

$r_i$  – internal radius of the insulation mm

$C$  – capacitance  $\mu\text{F}/\text{km}$

Electric stress

$$E_{max} = \frac{U_0}{r_1 \cdot \ln \left( \frac{r_e}{r_i} \right)}$$

$$E_{min} = \frac{U_0}{r_e \cdot \ln \left( \frac{r_e}{r_i} \right)}$$

where:

$r_e$  – external radius of the insulation mm

$r_i$  – internal radius of the insulation mm

$U_0$  – phase to earth voltage kV

$E_{max}$  – electric stress on conductor screen kV/mm

$E_{min}$  – electric stress on insulation kV/mm

Permissible side wall pressure

$$P = \frac{F}{R}$$

where:

$F$  – pulling force kN

$R$  – bending radius m

$P$  – side wall pressure kN/m

Dielectric loss

$$W = 2 \cdot \pi \cdot f \cdot U_0^2 \cdot C \cdot \text{tg} \delta$$

where:

$W$  – dielectric losses W/km

$f$  – frequency Hz

$U_0$  – phase to earth voltage kV

$C$  – capacitance  $\mu\text{F}/\text{km}$

$\text{tg} \delta$  – loss angle

Induction and inductive reactance

$$L = 2 \cdot \ln \cdot \left( \frac{k \cdot b}{r_o} \right) \cdot 10^{-1}$$

where:

$L$  – inductance mH/km

$k = 1$  for trefoil formation;  $k = 1.26$  for flat formation

$b$  – distance between cable axes mm

$r_o$  – mean conductor radius

(depends on number of wires) mm

$$X = \frac{2 \cdot \pi \cdot f \cdot L}{1000}$$

where:

$f$  – frequency Hz

$L$  – inductance mH/km

$X$  – inductive reactance  $\Omega/\text{km}$

Inductance calculation from the reactance 'X' stated in the catalogue tables

$$L = \frac{1000 \cdot X}{2 \cdot \pi \cdot f}$$

Maximum short circuit current

Maximum short circuit currents for duration of 1.0 s are stated in the catalogue.

To calculate maximum short circuit current for duration of 0.2 to 5.0 s the formula below is given.

$$I_{zt} = \frac{I_{z1}}{\sqrt{t_z}}$$

where:

$I_{z1}$  – maximum short circuit current for duration of 1.0 s kA

$I_{zt}$  – maximum short circuit current for duration of  $t_z$  kA

$t_z$  – short circuit duration s

Test voltage levels

Rated voltage and corresponding test voltages according to IEC

Nominal voltage kV	Type test	Routine tests		
	Impulse voltage kV	AC voltage test kV	Duration minutes	Partial discharge test at kV
45	250	65	30	39
66	325	90	30	54
110	550	160	30	96
132	650	190	30	114
150	750	218	30	131
220	1050	318	30	190
275	1050	400	30	240
330	1175	420	60	285
400	1425	440	60	330
500	1550	580	60	435

## Max. resistance and max. short-circuit current for conductors

Cross section mm <sup>2</sup>	Maximum D.C. resistance at 20°C Ω/km		Max. short-circuit current 1s, kA (90°C ÷ 250°C)	
	Copper	Aluminum	Copper	Aluminum
95	0.1930	0.3200	13.8	9.2
120	0.1530	0.2530	17.4	11.6
150	0.1240	0.2060	21.8	14.5
185	0.0991	0.1640	26.8	17.8
240	0.0754	0.1250	34.8	23.1
300	0.0601	0.1000	43.4	28.8
400	0.0470	0.0778	57.8	38.3
500	0.0366	0.0605	72.2	47.8
630	0.0283	0.0469	90.8	60.2
800	0.0221	0.0367	115.3	76.3
1000	0.0176	0.0291	144.0	95.3
1200	0.0151	0.0247	172.7	114.3
1400	0.0129	0.0212	201.4	133.2
1600	0.0113	0.0186	230.1	152.2
1800	0.0101	0.0165	258.8	171.2
2000	0.0090	0.0149	287.4	190.1
2500	0.0072	0.0120	359.1	237.5
3000	0.0062	0.0100	430.8	284.9

## Ampacity load factor

The permissible ampacity (current rating) is calculated on the assumption that the conductors load current flows constantly, whilst not exceeding the maximum continuous operating temperature of the cable's insulation. The maximum continuous permissible operating temperature for cables with XLPE insulation is 90°C. In practice the current flow is not constant.

### DEFINITION

Situation above is characterized by the load factor (LF – load factor) as the ratio of the average of load current (load cycle) to a maximum value of load current flowing during a one day (24 hour) period. Long-term permissible ampacity prolonged by a factor LF = 1 means that the average value of the load current during the day equals the maximum load current during the same period of time.

Duration time h	Load current A	Load cycle/Maximum load
0	151	0.302
1	124	0.247
2	114	0.227
3	116	0.232
4	118	0.235
5	123	0.246
6	145	0.290
7	300	0.600
8	500	1
9	475	0.950
10	470	0.940
11	455	0.910
12	446	0.892
13	385	0.770
14	386	0.772
15	400	0.800
16	427	0.853
17	498	0.996
18	427	0.853
19	395	0.790
20	370	0.740
21	370	0.740
22	361	0.722
23	300	0.600

LF=0.654

For cables laid direct in the ground the heating time constant is long and can take up to 200 hours. Therefore the acceptable ampacity of cables in the ground is increasing, if the current flow is changing cyclically. For cables operating in air, where cable heating time constant is much shorter (up to few hours), the increase of ampacity is only short increasing the current flow.

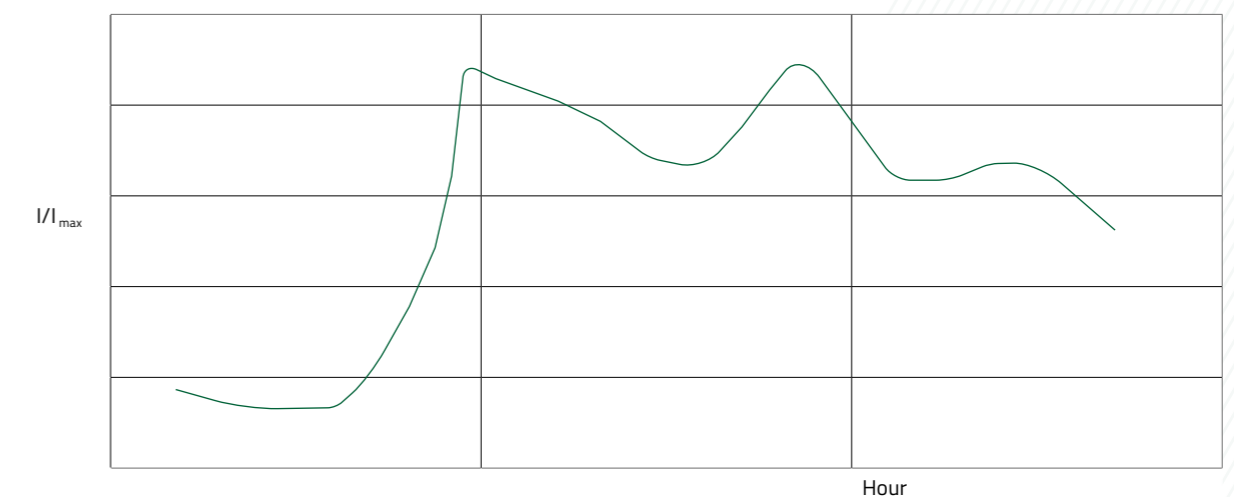

Temperature of conductor for operating cables depends not only on the current flowing at that moment, but also the overall level of current flow prior to this period. The example shown in the table of daily ampacity, the highest temperature occurs after 17.5 hours while the highest value of the current occurs at 8 hours cycle.

Knowing the load cycle, it is possible to increase ampacity of cables laid direct in the ground using the following factors:

		Correction factor										
Cross sectional area of conductor		Load factor										
mm <sup>2</sup>	1.00	0.95	0.90	0.85	0.80	0.75	0.70	0.65	0.60	0.55	0.50	
150 - 630	1.00	1.03	1.06	1.09	1.12	1.15	1.19	1.22	1.26	1.29	1.33	
800 - 1400	1.00	1.03	1.07	1.10	1.14	1.18	1.22	1.26	1.31	1.36	1.41	
1600 - 3000	1.00	1.03	1.07	1.11	1.15	1.19	1.24	1.29	1.34	1.39	1.45	

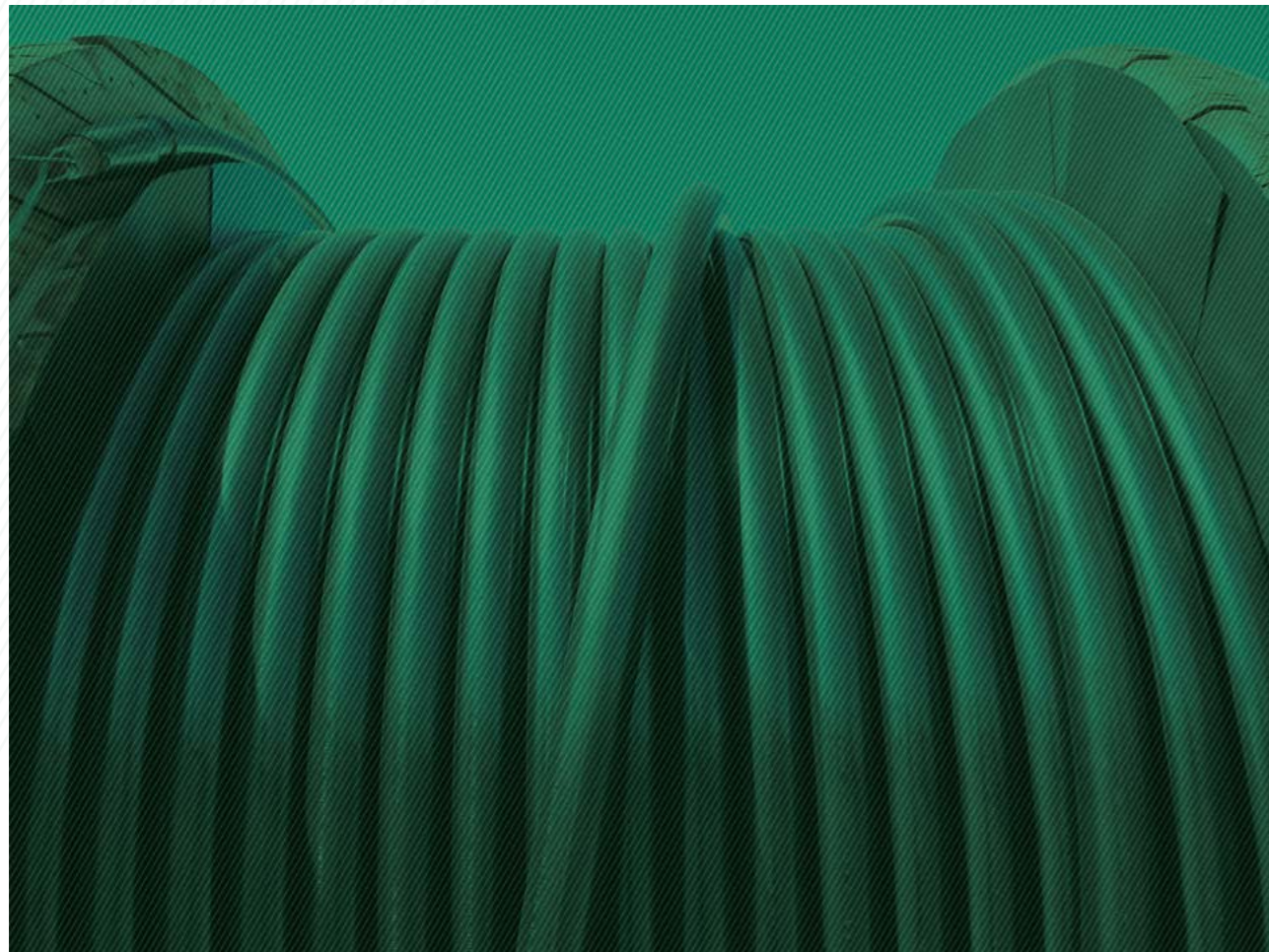

## Types of cable system bondings

### Both ends bonding

In both ends bonding, metallic screen of the cable is connected straight to the earth from both sides. Positive effect of such solution is elimination of induced voltage in screen. Drawback of such solution is flow of circulating current to the earth. This will cause losses in the screen, which reduce the cable current ampacity.

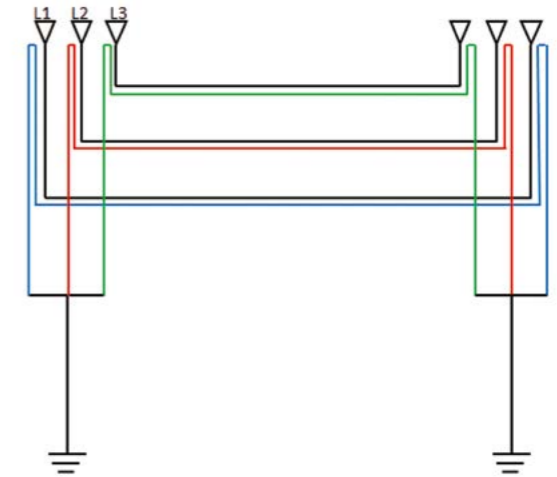

### Single point bonding

In single point bonding, metallic screen is connected straight to the earth from one side. Second side is connected to the surge voltage limiter. Positive effect of such solution are elimination of circulating currents and rise of cable current ampacity. Drawback of such solution are presence of induced voltage in screen, which is limits the maximum line length, and increase of costs due to necessity of surge voltage limiter apply.

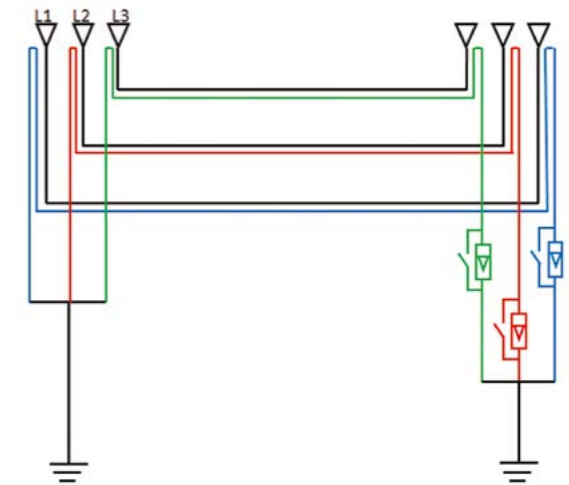

### Cross bonding

In cross-bonding cable system is divided into three minor sections. Start and the end of the metallic screen of the cable system is connected straight to earth. At sectionalizing joint screens are cross-connected, and earthed through surge voltage limiters in order to eliminate circulating current and reduce inducted voltage. This way of bonding permits as high cable current ampacity as in single point bonding, and longer line lengths. Drawback of such solution are additional cost of joints, link boxes and surge voltage limiters.

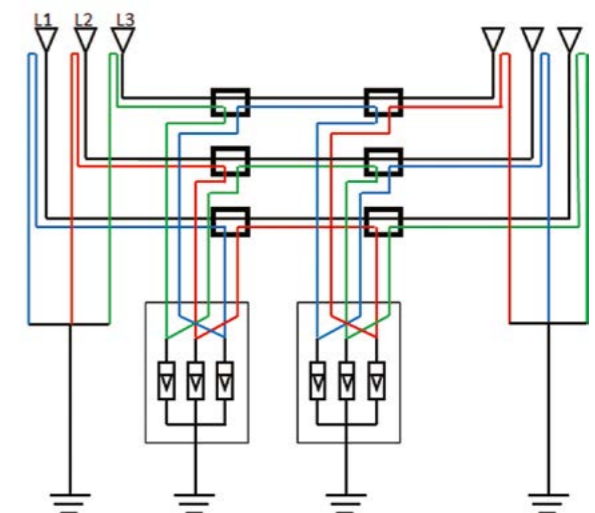

# Cable drums

## Sizes of wooden drums

Approximate capacity of wooden cable drums (in metres).

Cable diameter mm	Type of cable drum						
	28	30	32	34	37	40	43
57	1 060	1 420	2 600	2 220	2 890	4 080	4 930
58	1 060	1 420	2 520	2 150	2 820	3 970	4 800
59	1 020	1 380	2 270	2 150	2 820	3 590	4 800
60	1 020	1 380	2 270	2 150	2 750	3 490	4 700
61	970	1 330	2 210	2 090	2 750	3 490	4 300
62	970	1 330	2 210	1 820	2 330	3 400	4 180
63	970	1 330	2 150	1 760	2 330	3 400	4 180
64	970	1 290	1 900	1 760	2 270	2 950	4 080
65	780	1 080	1 840	1 700	2 270	2 950	4 080
66	780	1 030	1 840	1 700	2 200	2 870	3 590
67	780	1 030	1 840	1 700	2 200	2 870	3 590
68	740	1 030	1 790	1 650	2 140	2 790	3 500
69	740	1 000	1 790	1 410	1 830	2 790	3 500
70	740	1 000	1 790	1 410	1 830	2 790	3 500
71	740	1 000	1 520	1 360	1 780	2 390	3 060
72	710	960	1 520	1 360	1 780	2 390	3 060
73	710	960	1 520	1 360	1 720	2 320	2 960
74	710	960	1 470	1 310	1 720	2 320	2 960
75	710	960	1 470	1 310	1 720	2 320	2 960
76	540	740	1 470	1 310	1 660	2 250	2 880
77	540	740	1 420	1 260	1 660	2 250	2 880
78	540	740	1 220	1 260	1 660	1 960	2 570
79	540	740	1 220	1 050	1 340	1 880	2 480
80	540	710	1 220	1 050	1 340	1 880	2 480
81	520	710	1 180	1 010	1 340	1 880	2 480
82	520	710	1 180	1 010	1 290	1 820	2 390
83	520	710	1 180	1 010	1 290	1 820	2 390
84	520	680	1 180	1 010	1 290	1 820	2 390
85	520	680	1 130	970	1 290	1 820	2 390
86	490	680	1 130	970	1 250	1 760	2 030
87	490	680	1 130	970	1 250	1 760	2 030
88	490	650	960	970	1 250	1 500	2 030
89	490	650	920	920	1 250	1 500	2 030

Cable diameter mm	Type of cable drum						
	28	30	32	34	37	40	43
90	490	650		920	1 200	1 440	1 960
91	380	500		920	1 200	1 440	1 960
92	350	500		750	970	1 440	1 960
93	350	470		750	970	1 440	1 960
94	350	470		710	930	1 380	1 890
95		470		710	930	1 380	1 630
96		470		710	930	1 380	1 630
97		470		710	930	1 380	1 630
98		470		710	930	1 380	1 630
99		450		670	890	1 330	1 570
100		450		670	890	1 330	1 570
101		450		670	890	1 110	1 570
102		450		670	890	1 110	1 570
103		450		670	890	1 110	1 570
104		450		670	850	1 060	1 500
105		450		670	850	1 060	1 500
106				640	850	1 060	1 500
107				640	850	1 060	1 280
108				640	850	1 060	1 280
109				640	810	1 010	1 220
110				640	810	1 010	1 220
111				490	630	1 010	1 220
112				490	630	1 010	1 220
113				460	630	1 010	1 220
114				460	630	1 010	1 220
115				460	630	1 010	1 220
116					590	960	1 160
117					590	770	1 160
118					590	770	1 160
119					590	770	1 160
120					590	770	1 160
121					590	780	1 160
122					590	780	970
123					560	730	910
124					560	730	910
125					560	730	910
126					560	730	910
127					560	730	910
128					560	730	910





## Design-related and innovative approach

### N2XS(FL)2Y1 × 2500 400kV

**Description:**

1. Conductor – copper Milliken type
2. Inner semi-conductive screen over the conductor
3. XLPE Insulation
4. Outer semi-conductive screen over insulation
5. Water-blocking semi-conductive tape applied over the insulation semi-con screen
6. Metallic screen – copper wires and tapes and optical fibres in tubes for cable temperature measurement
7. Water-blocking semi-conductive tape applied over the metallic screen
8. Radial sealing – aluminum film
9. Outer sheath – black: MDPE, HDPE, LSOH

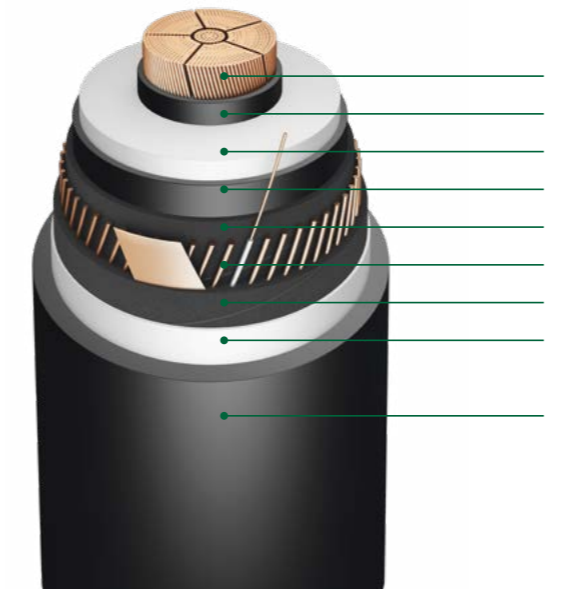

Due to unavoidable interfering in an already existing infrastructure as well as impact on natural environment, 400 kV cable systems constitute a real challenge for cable manufacturers and suppliers of cable accessories.

TFKable Group has over 25 years of experience in production High Voltage cables. Cable Systems for power transmission research and development programme was initiated in the Bydgoszcz plant in 1988. The first 110 kV cable system was supplied in 1992. Thanks to subsequent research connected with testing of high-end materials as well as numerous investments improving technological potential of the plant we were able to include into our product portfolio 400 kV cable system design ensuring safe and reliable operation of power transmission lines.

We are able to provide full support regarding design and supply of High Voltage and Extra High Voltage cable systems:

- designing and optimization of cable design and all crucial electrical parameters, including current carrying capacity calculations
- consulting in the field of cable system design including selection of additional elements of the cable system and optimization of cable operating conditions
- preparation of complete quotations for HV and EHV and cable systems, including supply of cable and accessories, installation and on-site acceptance tests.

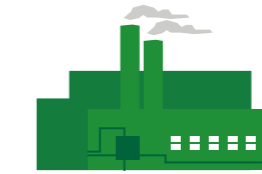

Our engineers have designed an innovative 2XS(FL)2Y-2T4FM 1 × 2,500 RMS /150 220/400kV cable construction capable of transmitting approximately 1,400 MVA at voltage level of 400 kV.



In addition to the abovementioned cable, the cable system consists of the following accessories: ESS420-C166 composite overhead termination, ESP420-C156 porcelain overhead termination, CONNEX plug-in terminations (size 8), together with MSA420-XKMG and MSA420-DOG cable joints.

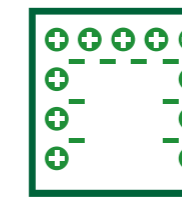

Both the cable and the accessories forming the complete cable system were subjected to thorough type test in a Faraday chamber in accordance with the IEC 62067 standard. Additionally, the cable system underwent annual Prequalification test in a specially constructed test field, in which natural operating conditions of cable system were simulated, i.e. the cable was installed in a tunnel, in the open air, as well as underground.



The tests were conducted in the TFK manufacturing plant in Bydgoszcz in the specially constructed test field in accordance with the requirements of IEC 62027 international standard and were attested with the certificate issued by the Certification Institute. As a result, we are now able to offer a cable design with fully compatible technology that ensures safe and reliable power transmission at 400 kV.

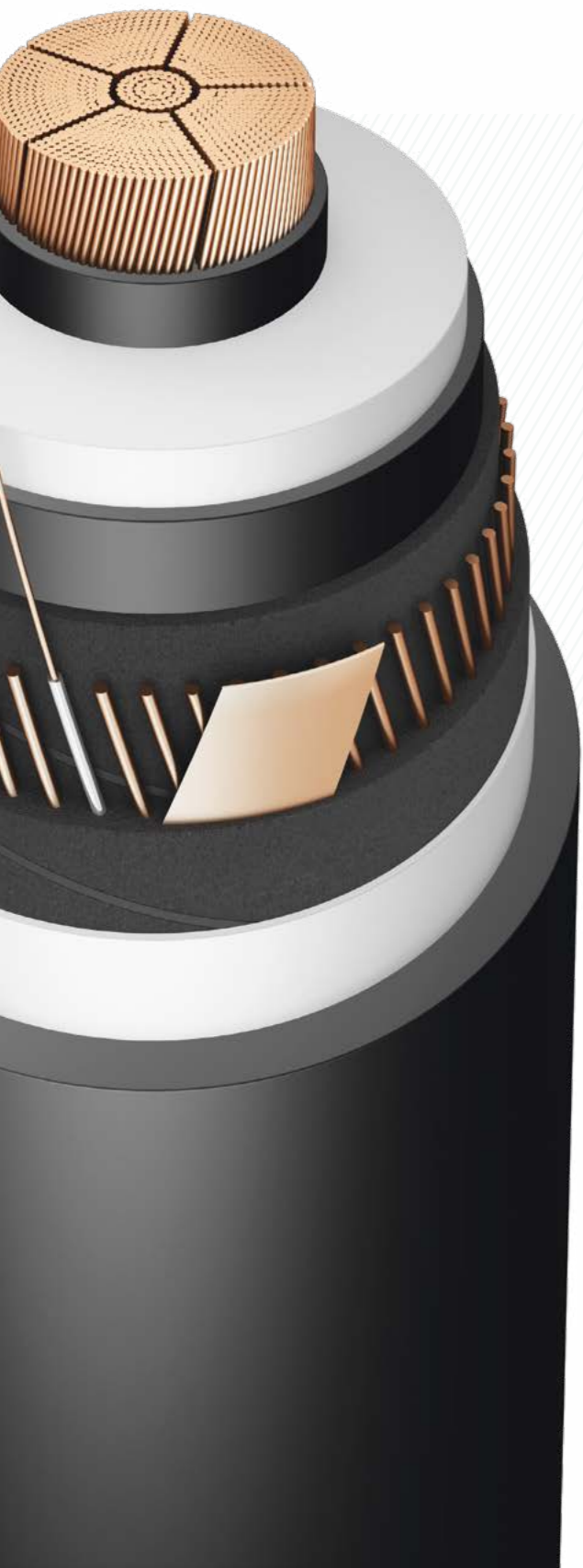

## Efficient and safe electrical power transmission system

N2XS(FL)2Y1 × 2500 400kV

In order to fulfill the strictest requirements of transmission system operators, TELE-FONIKA Kable in its manufacturing plant in Bydgoszcz have developed an installation design and conducted a type test of a 400kV cable system, which was witnessed by German Testing and Certification Institute VDE. Successful completion of all works, during which requirements regarding reliable and safe operation of the system as well as environmental aspects were taken into consideration at all times, allowed for development of a complete cable system for power transmission in High Voltage and Extra High Voltage networks.



TELE-FONIKA Kable S.A.

The High Voltage Team  
ul. Hipolita Cegielskiego 1  
32-400 Myślenice, Poland  
T. (+48) 12 372 7301  
T. (+48) 12 372 7302  
T. (+48) 12 372 7303  
T. (+48) 12 372 7304  
T. (+48) 12 372 7360

[hvcs@tfkable.com](mailto:hvcs@tfkable.com)

[www.tfkable.com](http://www.tfkable.com)

Edition V

All Rights Reserved – TELE-FONIKA Kable S.A.